

Technical manual

# PP-R Pipe system for H&C application

POLYMUTAM





# TABLE OF CONTENTS

## System description

1.1	POLYMUTAN Installation system .....	6
1.1.1	System components.....	6
1.1.2	Material-related guide values of PP-R .....	6
1.1.3	Material-related guide values of PP-RCT .....	7
1.1.4	Fields of application.....	7
1.1.5	Possible uses .....	7
1.2	POLYMUTAN pipes .....	8
1.2.1	Overview .....	8
1.2.2	Technical datas.....	9
1.2.3	POLYMUTAN ML5.....	10
1.2.4	UV ML5 .....	12
1.2.5	Declaration of pipe labelling .....	14
1.3	Product line .....	15
1.3.1	POLYMUTAN pipes .....	15
1.3.2	POLYMUTAN fittings.....	16
1.3.3	POLYMUTAN adapters .....	21
1.3.4	POLYMUTAN fittings and accessories .....	24
1.3.5	POLYMUTAN shut-off devices and accessories .....	26
1.3.6	POLYMUTAN welding machines, tools and accessories.....	27

## Transportation and storage

2.1	Safety instructions and intended use .....	33
-----	--	----

## Drinking water hygiene

3.1	Drinking water .....	34
3.2	Types of installation .....	35
3.2.1	Connection of drinking water tapping points.....	35

## System requirements

4.1	Standards and regulations.....	36
4.1.1	Planning of drinking water installation systems .....	36
4.1.2	System-specific standards .....	36
4.2	Terms used.....	37
4.2.1	Standard dimension ratio.....	37
4.2.2	Pipe series number S .....	37
4.2.3	Nominal pressure (PN).....	37
4.3	Requirements on pipe systems .....	38
4.3.1	Classification of operational conditions .....	38
4.3.2	Table of working pressure.....	39
4.3.3	Stress that a pipe system is exposed to .....	40
4.4	Chemical resistance .....	41
4.5	Disinfection.....	42
4.5.1	Thermal disinfection.....	42
4.5.2	Chemical disinfection – “shock disinfection” .....	43
4.5.3	Continuous metered addition of chemicals – “permanent disinfection” ...	43

# TABLE OF CONTENTS

## Planning and design

5.1	Dimensioning of drinking water systems.....	44
5.1.1	Differentiating calculation procedure.....	44
5.1.2	Minimum flow pressures of tapping points.....	45
5.1.3	Peak flow rate according to DIN 1988.....	46
5.1.4	Single resistance values z.....	48
5.1.5	Pressure loss tables .....	49
5.2	Simplified procedure.....	57

## Welding technology

6.1	Basic information.....	60
6.1.1	Socket welding using a heated tool .....	60
6.1.2	Guidelines.....	60
6.2	Processing information for welding .....	61
6.2.1	Socket welding with a hand-held welding device, from 20 mm.....	61
6.2.2	Socket welding with a stationary welding machine, from 40 mm .....	63
6.2.3	Welding saddle for 40–110 mm.....	64
6.2.4	Repair plugs .....	65
6.2.5	Use of electric welding sockets.....	66

## Assembly guidelines

7.1	Fastening techniques.....	68
7.1.1	Fixed points .....	68
7.1.2	Sliding points.....	68
7.2	Mounting distances .....	69
7.3	Laying the pipes .....	70
7.4	Length variation .....	71
7.5	Thermal expansion force .....	73
7.6	Expansion compensation .....	74
7.6.1	Bending legs .....	74
7.6.2	Expansion loop.....	75
7.6.3	Pre-tensioning .....	75
7.7	Insulation .....	76
7.7.1	Hot water insulation .....	76
7.7.2	Cold water insulation .....	77
7.7.3	Dew point .....	77
7.8	Noise protection .....	79
7.9	Fire protection.....	80

# TABLE OF CONTENTS

## **Initial operation**

8.1	Pressure-tests .....	81
8.2	Flushing the system .....	84
8.3	Initial operation .....	84

## **Quality management**

9.1	Quality assurance .....	86
9.1.1	Approvals .....	88
9.1.2	Testing institutes for product monitoring and certification .....	88
9.4	Sustainability .....	89

## **General information**

The information provided in this technical manual is intended to help you select our products for your application. Text and images were compiled with utmost care. Nevertheless, errors cannot be entirely excluded. POLYMELT does not assume legal liability or any other form of liability for erroneous information and its consequences. POLYMELT is grateful for any suggestions or comments.

We are happy to provide further information – please contact the POLYMELT Sales Office on +49 8342 70060, mail@polymelt.de

# SYSTEM DESCRIPTION

## 1.1 POLYMUTAN pipe system made of PP-R

The POLYMUTAN installation system consists of various pipes designed for various fields of application and guarantees a flawless supply of the most precious of all comestibles: drinking water.

### Connection Technique using Heated-Tool Socket Welding

When the pipe and the fitting are welded, their plastic materials fuse together to form a homogeneous, firmly bonded whole. Special tools are used to heat up pipe and fitting, which are then just joined together. This connection is reliable and lastingly leakproof.

### 1.1.1 System components

#### 1.1.1.1 Fittings

The PP-R-metal connection of the POLYMUTAN fittings excels by its leakproofness and resistance to torsion. This connection withstands decades of operational loads without any difficulty. Thanks to the specific geometry of their inserts, which are made of high-grade brass, the moulded parts meet the highest safety standards and guarantee safe laying.

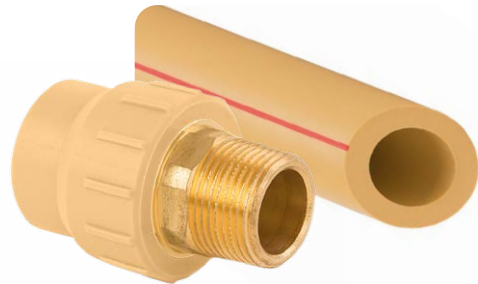

The metal threads of the POLYMELT brass components meet the requirements of the DIN EN 10226 standard and are manufactured from high-quality brass. Moreover, the material complies with the current version of the recommendations (as at 2014) of the Federal Environment Agency on “Materials suitable from a drinking water hygiene point of view”. This guarantees that the limit values of the “Deutsche Trinkwasserverordnung (TrinkwV 2001)” (German Drinking Water Ordinance) are reliably observed. All POLYMUTAN fittings are compatible with all POLYMUTAN pipes (refer to page 8 and following).

#### 1.1.1.2 Pipes and fittings

All pipes and fittings of the POLYMUTAN installation system are made of PP-R, with only high-quality raw materials being used. This raw material is equipped with high-grade stabilizers. The stabilizer package protects the polymer from oxidation, which may occur, for example, following long-term exposure to high temperatures > 70 °C and high pressure.

### 1.1.2 Material-related guide values of PP-R

Properties	Measuring method	Unit	Value
Density	ISO 1183	kg/m <sup>3</sup>	898
Melt Flow Rate 230 °C/2.16 kg	ISO 1133	g/10 min.	0.3
Modulus of Elasticity in Tension (1mm/min)	ISO 527	MPa	900
Tensile Stress at Yield (50 mm/min)	ISO 527	Mpa	28
Charpy Impact Strength, notched ( +23 °C)	ISO 179	kJ/m <sup>2</sup>	25
Coefficient of linear expansion	DIN 53752	mm/mK	0.15
Thermal conductivity	DIN 52612	W/mK	0.24
Pipe surface roughness k		mm	0.007
Specific heat at 20 °C	Calorimeter	KJ/kg K	2.0



# SYSTEM DESCRIPTION

## 1.1.3 Material-related guide values of PP-RCT

Properties	Measuring method	Unit	Value
Density	ISO 1183	kg/m <sup>3</sup>	905
Melt Flow Rate 230 °C/2.16 kg	ISO 1133	g/10 min.	0.3
Modulus of Elasticity in Tension (1mm/min)	ISO 527	MPa	900
Tensile Stress at Yield (50 mm/min)	ISO 527	MPa	25
Charpy Impact Strength, notched ( +23 °C)	ISO 179	kJ/m <sup>2</sup>	40
Coefficient of linear expansion	DIN 53752	mm/mK	0.15
Thermal conductivity	DIN 52612	W/mK	0.24
Pipe surface roughness k		mm	0.007
Specific heat at 20 °C	Calorimeter	KJ/kg K	2.0

## 1.1.4 Fields of application

For more than 30 years, polypropylene has been successfully used in supply lines of buildings in many countries worldwide. The combination of such excellent properties as chemical resistance, homogeneous connection, resistance to pressure and easy laying make it a reliable and lasting system suitable for various applications. In many countries it is gradually replacing such traditional materials as copper and galvanized steel.

### Properties of POLYMUTAN

- **Enormous durability** thanks to high-quality materials and processing
- **Homogeneous connection** guarantees high operational reliability.
- **High demands for hygiene** guarantee perfect water quality.
- **Good thermal load capacity**, therefore high operational reliability.
- **High chemical resistance** guarantees high durability.
- **Minor flow noise** makes living highly comfortable.
- **High dimensional accuracy and low weight**, therefore time- and cost-saving pipe laying.

## 1.1.5 Possible uses

The POLYMUTAN installation system fulfils a variety of demands made on supply lines. It is suitable for universal use in:

- New buildings
- Refurbishment
- Repairs;

in **drinking water installations** for cold and hot water pipes in residential buildings, hospitals, hotels, office buildings, schools, etc., for example:

- Service connections
- Boiler connections
- Water distributing systems
- Rising lines
- Floor-level distribution
- Fittings

as well as **piping networks** for:

- Rainwater systems
- Outside pipe laying

SYSTEM DESCRIPTION

TRANSPORTATION AND STORAGE

DRINKING WATER HYGIENE

SYSTEM REQUIREMENTS

PLANNING AND DESIGN

WELDING TECHNOLOGY

ASSEMBLY GUIDELINES

INITIAL OPERATION

QUALITY MANAGEMENT

# SYSTEM DESCRIPTION

SYSTEM DESCRIPTION

- Compressed air systems
- Agriculture and horticulture
- Industries, for example the transportation of aggressive media (acids, alkaline solutions, etc.), taking into account its resistance to chemical agents
- Heating installations
- Shipbuilding
- Further media and possible applications upon request.

TRANSPORTATION AND STORAGE

**POLYMUTAN is not suitable for:**

- Industrial gases
- Flammable liquids and gases
- Coolants/refrigerants

DRINKING WATER HYGIENE

## 1.2 POLYMUTAN Pipes

### 1.2.1 Overview

**POLYMUTAN**, the high-grade installation pipe made of polypropylene, **POLYMUTAN ML5** and **UV ML5**, the multilayer fibre-reinforced composite pipes, guarantee reliable, durable and flawless supply in installation systems.

Wall thickness, pipe material and temperature range are the factors that decide the level of the resistance of a plastic pipe system to pressure.

SYSTEM REQUIREMENTS

POLYMELT pipes are available in various wall thicknesses:

PLANNING AND DESIGN

		Product range overview POLYMUTAN pipes								
	SDR	20	25	32	40	50	63	75	90	110
<b>POLYMUTAN</b>	6									
<b>POLYMUTAN</b>	11									
<b>POLYMUTAN ML5</b>	7,4									
<b>UV ML5</b>	7,4									

WELDING TECHNOLOGY

Pipes 20–125 mm = socket welding

ASSEMBLY GUIDELINES

INITIAL OPERATION

POLYMELT pipes made of PP-R and PP-RCT are manufactured according to DIN EN ISO 15874, EN ISO 21003 and DIN 8077/78 and fulfil their quality requirements.

QUALITY MANAGEMENT



# SYSTEM DESCRIPTION

## 1.2.2 Technical datas

		POLYMUTAN			UV
		Single layer	Single layer	Fiber ML 5	Fiber ML 5
					
<b>Material</b>		PP-R	PP-R	PP-RCT	PP-R
<b>Pipe Series</b>		SDR 11/S 5	SDR 6/S 2,5	SDR 7,4/S 3,2	SDR 7,4/S 3,2
<b>Diameter in mm</b>		20-110	20-110	20-110	20-63
<b>Admissible Working pressure acc. DIN 8077, SF1,25</b>	20°C	15,5 bar	30,9 bar	26,7 bar	24,5 bar
	70°C	5,1 bar	10,2 bar	11,2 bar	8,1 bar
<b>Coefficient of linear expansion <math>\alpha</math></b>		0,15 mm/mK	0,15 mm/mK	0,038 mm/mK	0,038 mm/mK
<b>Product standard</b>	DIN 8077/8078, EN ISO 15874, ASTM2389				
<b>Fire behaviour DIN 4102</b>	B2				
<b>Fire Behaviour EN13501</b>	E				
<b>Thermal Conductivity <math>\lambda</math></b>	0,24 W m/K				
<b>Connection Technology</b>	According DVS 2207/11 by socket, butt and electro fusion				
<b>Special properties</b>				<p>Innovative 5 - Layer fiber pipe with increased stability and low length elongation. Two layers with fiber reinforcement provides excellent properties such as reduced linear expansion, deformation and excellent stability.</p> <p>75% reduction in linear expansion tested and approved by a third party.</p>	
					First layer with UV protection by special stabilised PP-R
<b>Warranty</b>	10 Years				

SYSTEM DESCRIPTION

TRANSPORTATION AND STORAGE

DRINKING WATER HYGIENE

SYSTEM REQUIREMENTS

PLANNING AND DESIGN

WELDING TECHNOLOGY

ASSEMBLY GUIDELINES

INITIAL OPERATION

QUALITY MANAGEMENT

# SYSTEM DESCRIPTION

SYSTEM DESCRIPTION

## 1.2.3 POLYMUTAN ML5

The POLYMUTAN ML5 pipe represents a milestone in PP-R development. A 5 layer fiber pipe available with PP-R and PP RCT material.

TRANSPORTATION AND STORAGE

### 1.2.3.1 Properties of the material

PP-RCT: Polypropylene random copolymer with modified crystalline structure and increased resistance to elevated temperatures. This material represents a new generation of the tried and tested PP-R material. Especially with higher temperatures, the increased crystallinity of PP-RCT provides an improved creep-depending-on-time behaviour under internal compression.

PP = polypropylene

R = random

C = crystallinity

T = temperature

DRINKING WATER HYGIENE

This is why pipes made from this material can have thinner walls and consequently larger inner diameters. Designers and plumbers are offered convincing advantages from this circumstance. Thanks to the larger inner diameter, the hydraulic capacity of the pipes increases, which is specifically advantageous in systems that need to transport large amounts of water, for example in high-rise buildings.

SYSTEM REQUIREMENTS

Pipes made of PP-RCT are accepted according to the EN ISO 15874 standard and the EN ISO 21003 standard on multilayer pipes, and represent the state of the art. The same well-tried connection technique is used for pipes and fittings made of PP-RCT as for PP-R pipes.

PLANNING AND DESIGN

### Distribution of layers

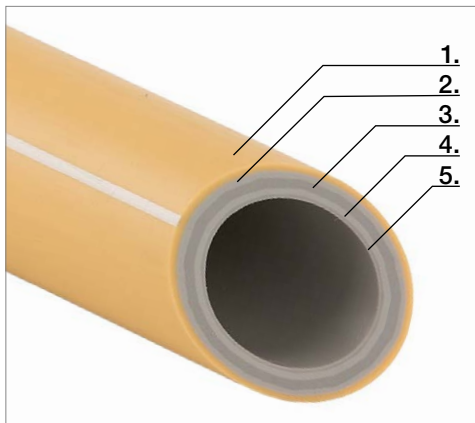

#### 1. Layer PP-R

#### 2. Layer PP-R with fiber reinforcement

The perfect connection of glass fibre and PP-R / PP-RCT provides excellent linear expansion, deformation properties as well as good resistance to impact loads.

#### 3. Layer PP-RCT

#### 4. Layer PP-R with fiber reinforcement

The two separate fiber layers offers a perfect stability and therefore a easier installation of the pipe

#### 5. Layer PP-RCT

WELDING TECHNOLOGY

ASSEMBLY GUIDELINES

5 layers – 5 benefits!

Quality – made in Germany.

INITIAL OPERATION

QUALITY MANAGEMENT

# SYSTEM DESCRIPTION

## 1.2.3.3 Advantages

- **Lower linear expansion** reduced by 75 % as compared to a PP-R standard pipe
- **Improved resistance to internal pressure** at increased temperatures as compared to a PP-R standard pipe, thanks to the PP-RCT material
- **Increased stability** allows longer distances between the fastening points
- **Increased flow rate** increased by approximately 16 % thanks to thinner walls at unchanged dimension and pressure strain
- **Higher resistance to impact loads** – special compound materials increase the resistance to impact loads

## 1.2.3.5 Comparison of linear expansion

This comparison distinctly shows the linear expansion caused by temperature changes of a standard PP-R pipe and the POLYMUTAN ML5 pipe.  
Linear expansion reduces by 75 %.

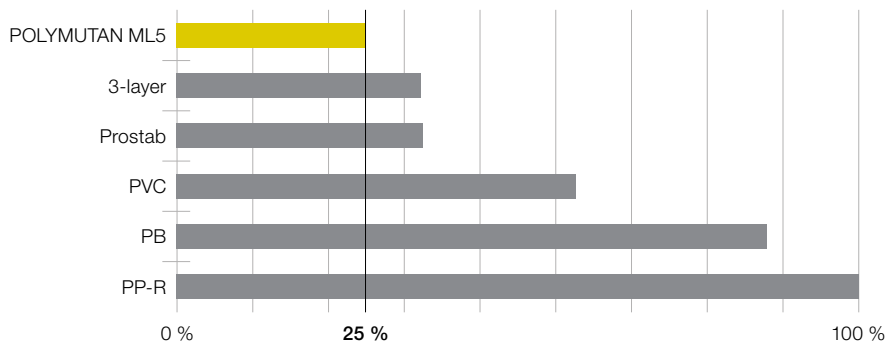

Comparison of linear expansion values

SYSTEM DESCRIPTION

TRANSPORTATION AND STORAGE

DRINKING WATER HYGIENE

SYSTEM REQUIREMENTS

PLANNING AND DESIGN

WELDING TECHNOLOGY

ASSEMBLY GUIDELINES

INITIAL OPERATION

QUALITY MANAGEMENT

# SYSTEM DESCRIPTION

## 1.2.4 UV ML5

The UV ML5 pipe is a further development of the ML5 pipe series.

### 1.2.4.1 Properties of the material

The pipe structure has been adopted from the POLYMUTAN ML5 pipe, only the exterior layer has been modified. Thanks to this UV resistant layer, this pipe is particularly suitable for laying of supply lines in outdoor areas, for example, in drinking water systems, irrigation systems, heating and cooling water systems.

#### Distribution of layers

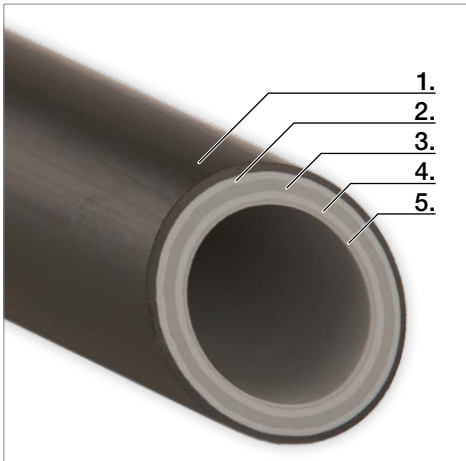

#### 1. Layer PP-R

First layer with UV protection by special stabilised PP-R proven by a third party company

#### 2. Layer PP-R with fiber reinforcement

The perfect connection of glass fibre and PP-R provides excellent linear expansion, deformation properties as well as good resistance to impact loads.

#### 3. Layer PP-R

#### 4. Layer PP-R with fiber reinforcement

The two separate fiber layers offers a perfect stability and therefore a easier installation of the pipe

#### 5. Layer PP-R

#### Processing

The pipes are installed using the existing fittings programme, without any additional operations. The UV ML5 pipe can be welded directly, with no need of peeling off the outer layer. Thus, pipes and fittings can be installed in the usual simple and safe way.

In Combination with our special range of UV resistant black fittings we can offer a full system solution for any kind of outdoor application.

SYSTEM DESCRIPTION

TRANSPORTATION AND STORAGE

DRINKING WATER HYGIENE

SYSTEM REQUIREMENTS

PLANNING AND DESIGN

WELDING TECHNOLOGY

ASSEMBLY GUIDELINES

INITIAL OPERATION

QUALITY MANAGEMENT

# SYSTEM DESCRIPTION

## 1.2.4.4 Advantages

- **10 years of warranty** on resistance to UV radiation has been confirmed by a third party
- **No additional operations required** – usual and safe homogeneous welding of pipe and moulded part
- **Low linear expansion** – reduced by 75 % as compared to a PP-R standard pipe
- **Increased stability** allows longer distances between the fastening points
- **Increased flow rate** – increased by approximately 16 % thanks to thinner walls, with the dimensions and the pressure strain remaining unchanged.
- **Higher resistance to impact loads** – special compound materials increase the resistance to impact loads

## 1.2.4.5 Examined Resistance to UV Radiation

The resistance of the UV ML5 pipe to UV radiation has been tested by an acknowledged testing laboratory. During the entire test period samples were taken at certain intervals, which were then subjected to strength tests to examine them for possible changes of the material's mechanical properties. At the same time, material stability tests were carried out on a regular basis. The radiation intensity used for these tests was the same as in Aswan / Egypt over a period of more than 10 years.

**UV-RESISTANT**

SYSTEM DESCRIPTION

TRANSPORTATION AND STORAGE

DRINKING WATER HYGIENE

SYSTEM REQUIREMENTS

PLANNING AND DESIGN

WELDING TECHNOLOGY

ASSEMBLY GUIDELINES

INITIAL OPERATION

QUALITY MANAGEMENT

# SYSTEM DESCRIPTION

## 1.2.5 Declaration of pipe labelling

Polymelt pipes are labeled according the standards. An example of an pipe description and the meaning of the values are describet below:

Outer diameter × wall thickness	25 × 4.2
Product name	POLYMUTAN
Designation of material	PP-R
SDR wall thickness ratio	SDR 6
Pipe series S	S 2.5
Dimensional class according to EN ISO 15874	A
Class of application and admissible operational pressure according to EN ISO 15874	Class 1/10 bar, Class 2/8 bar
Working pressure	20 bar/20C, 10 bar/70C
Suitability for drinking water	TW
Impermeability to light	opaque
Product standards	DIN 8077/8078, EN ISO 15874
Certificates, approvals	SKZ A 553
Material labelling	Material
Machine number	Machine
Date of manufacture	DAY MONTH YEAR HOUR:MINUTE
Manufacturer	POLYMELT

### Imprint and order:

25 × 4.2 **POLYMUTAN MADE IN GERMANY**

PP-R SDR 6/S 2.5 A Class 1/10 bar Class 2/8 bar 20 bar/20C 10 bar/70C TW opaque  
 DIN 8077/78 EN ISO 15874 SKZ A 553 Material Machine Day Month Year Hour:Minute

SYSTEM  
DESCRIPTION

TRANSPORTATION  
AND STORAGE

DRINKING WATER  
HYGIENE

SYSTEM  
REQUIREMENTS

PLANNING AND  
DESIGN

WELDING  
TECHNOLOGY

ASSEMBLY  
GUIDELINES

INITIAL  
OPERATION

QUALITY  
MANAGEMENT

# SYSTEM DESCRIPTION

## 1.3 Product line

### 1.3.1 POLYMUTAN Pipes

**POLYMUTAN Pipe SDR 6 / S 2.5 PP-R** for hot and cold water acc. to DIN 8077/78 and EN ISO 15874, class 1/10 bar, class 2/8 bar, DVGW-AS2288, ÖVGW W 1.118, colour curry with red line



A. no.	Outer Ø mm	Wall thickness mm	Inner Ø mm	DN	Water Content l/m	Weight kg/m	Packing unit parcel/bar	Availability
10002	20	3.4	13.2	12	0.137	0.172	100 m / 4 m	S
10003	25	4.2	16.6	15	0.216	0.266	60 m / 4 m	S
10004	32	5.4	21.2	20	0.353	0.434	40 m / 4 m	S
10005	40	6.7	26.6	25	0.556	0.671	20 m / 4 m	S
10006	50	8.3	33.4	32	0.866	1.040	20 m / 4 m	S
10007	63	10.5	42.0	40	1.385	1.650	12 m / 4 m	S
10008	75	12.5	50.0	50	1.936	2.340	8 m / 4 m	S
10009	90	15.0	60.0	-	2.827	3.360	4 m / 4 m	S
10010	110	18.3	73.4	65	4.208	5.010	4 m / 4 m	S

**POLYMUTAN Pipe SDR 11 / S 5 PP-R** for cold water acc. to DIN 8077/78 and EN ISO 15874, class 1/6 bar, class 2/4 bar, colour curry with blue line



A. no.	Outer Ø mm	Wall thickness mm	Inner Ø mm	DN	Water Content l/m	Weight kg/m	Packing unit parcel/bar	Availability
10102	20	1.9	16.2	15	0.206	0.107	100 m / 4 m	S
10103	25	2.3	20.4	20	0.327	0.164	60 m / 4 m	S
10104	32	2.9	26.2	25	0.531	0.261	40 m / 4 m	S
10105	40	3.7	32.6	32	0.834	0.412	20 m / 4 m	S
10106	50	4.6	40.8	40	1.307	0.638	20 m / 4 m	S
10107	63	5.8	51.4	50	2.075	1.010	12 m / 4 m	S
10108	75	6.8	61.4	-	2.941	1.410	8 m / 4 m	S
10109	90	8.2	73.6	65	4.254	2.030	4 m / 4 m	S
10110	110	10.0	90.0	80	6.362	3.010	4 m / 4 m	S

**POLYMUTAN ML5 Fibre Pipe SDR 7.4 / S 3.2 PP-R, PP-RCT** for hot and cold water acc. to DIN 8077/78 and EN ISO 15874, class 1/8 bar, class 2/8 bar, SKZ certificate A 634, colour curry with silver line



A. no.	Outer Ø mm	Wall thickness mm	Inner Ø mm	DN	Water Content l/m	Weight kg/m	Packing unit parcel/bar	Availability
10322	20	2.8	14.4	15	0.163	0.149	100 m / 4 m	S
10323	25	3.5	18.0	20	0.254	0.236	60 m / 4 m	S
10324	32	4.4	23.2	25	0.423	0.385	40 m / 4 m	S
10325	40	5.5	29.0	32	0.661	0.584	20 m / 4 m	S
10326	50	6.9	36.2	40	1.029	0.916	20 m / 4 m	S
10327	63	8.6	45.8	50	1.647	1.474	12 m / 4 m	S
10328	75	10.3	54.4	-	2.324	2.048	8 m / 4 m	S
10329	90	12.3	65.4	65	3.359	2.922	4 m / 4 m	S
10330	110	15.1	79.8	80	5.001	4.374	4 m / 4 m	S



# SYSTEM DESCRIPTION

SYSTEM DESCRIPTION

**UV ML5 Fibre Pipe with UV protection layer, SDR 7.4 / S 3.2 / PP-R** for hot and cold water acc. to DIN 8077/78 and EN ISO 15874, class 1/8 bar, class 2/6 bar, 70°/8 bar, 20°/20 bar colour black



A. no.	Outer Ø mm	Wall thickness mm	Inner Ø mm	DN	Water Content l/m	Weight kg/m	Packing unit parcel/bar	Availability
40322	20	2.8	14.4	15	0.163	0.149	100 m / 4 m	S
40323	25	3.5	18.0	20	0.254	0.236	60 m / 4 m	S
40324	32	4.4	23.2	25	0.423	0.385	40 m / 4 m	S
40325	40	5.5	29.0	32	0.661	0.584	20 m / 4 m	S
40326	50	6.9	36.2	40	1.029	0.916	20 m / 4 m	S
40327	63	8.6	45.8	50	1.647	1.474	12 m / 4 m	S

TRANSPORTATION AND STORAGE

DRINKING WATER HYGIENE

**Support for pipes, galvanized** for horizontally installed pipes, self-clamping up to Ø 75 mm



A. no.	Diameter (d) mm	Packing unit parcel/bar
14902	20	75 / 3 m
14903	25	75 / 3 m
14904	32	75 / 3 m
14905	40	15 / 3 m
14906	50	15 / 3 m
14907	63	15 / 3 m
14908	75	15 / 3 m
14909	90	15 / 3 m
14910	110	15 / 3 m

SYSTEM REQUIREMENTS

PLANNING AND DESIGN

## 1.3.2 POLYMUTAN Fittings

**POLYMUTAN Long cross-over section**



A. no.	Diameter (d) mm	Supply unit cardboard box/package	Availability
10502	20	150 / 10	S
10503	25	100 / 10	S
10504	32	70 / 10	S

WELDING TECHNOLOGY

**POLYMUTAN Short cross-over section**



A. no.	Diameter (d) mm	Supply unit cardboard box/package	Availability
11502	20	120 / 10	S
11503	25	80 / 10	S

ASSEMBLY GUIDELINES

INITIAL OPERATION

QUALITY MANAGEMENT

# SYSTEM DESCRIPTION

<b>POLYMUTAN Welding socket</b> 	A. no.	Diameter (d) mm	Packing unit carton/bag	Avail-ability
	11002	20	600 / 10	S
	11003	25	400 / 10	S
	11004	32	250 / 10	S
	11005	40	170 / 10	S
	11006	50	100 / 5	S
	11007	63	50 / 1	S
	11008	75	40 / 1	S
	11009	90	24 / 1	S
	11010	110	15 / 1	S

<b>POLYMUTAN Reducer male / female</b> 	A. no.	Diameter (d) mm	Packing unit carton/bag	Avail-ability
	11603	25 / 20	300 / 10	S
	11605	32 / 20	250 / 10	S
	11606	32 / 25	200 / 10	S
	11608	40 / 20	400 / 5	S
	11609	40 / 25	300 / 5	S
	11610	40 / 32	200 / 5	S
	11612	50 / 20	250 / 5	S
	11613	50 / 25	150 / 5	S
	11614	50 / 32	200 / 5	S
	11615	50 / 40	150 / 5	S
	11618	63 / 25	100 / 1	S
	11619	63 / 32	120 / 1	S
	11620	63 / 40	100 / 1	S
	11621	63 / 50	75 / 1	S
	11627	75 / 50	50 / 1	S
	11628	75 / 63	50 / 1	S
	11634	90 / 50	40 / 1	S
	11635	90 / 63	40 / 1	S
	11636	90 / 75	30 / 1	S
11643	110 / 63	30 / 1	S	
11644	110 / 75	25 / 1	S	
11645	110 / 90	20 / 1	S	

<b>POLYMUTAN welding elbow 90°</b> 	A. no.	Diameter (d) mm	Packing unit carton/bag	Avail-ability
	11042	20	500 / 10	S
	11043	25	300 / 10	S
	11044	32	150 / 10	S
	11045	40	100 / 5	S
	11046	50	50 / 5	S
	11047	63	25 / 1	S
	11048	75	15 / 1	S
	11049	90	12 / 1	S
	11050	110	12 / 1	S

# SYSTEM DESCRIPTION

SYSTEM DESCRIPTION

## POLYMUTAN welding elbow male/female



A. no.	Diameter (d) mm	Packing unit carton/bag	Availability
11062	20	250 / 10	S
11063	25	150 / 10	S
11064	32	80 / 10	S
11065	40	40 / 5	S

TRANSPORTATION AND STORAGE

## POLYMUTAN welding elbow 45°



A. no.	Diameter (d) mm	Packing unit carton/bag	Availability
11102	20	200 / 10	S
11103	25	150 / 10	S
11104	32	100 / 10	S
11105	40	50 / 5	S
11106	50	25 / 5	S
11107	63	12 / 1	S
11108	75	20 / 1	S
11109	90	15 / 1	S
11110	110	8 / 1	S

DRINKING WATER HYGIENE

SYSTEM REQUIREMENTS

## POLO-POLYMUTAN butt welding elbow 45° male/female



A. no.	Diameter (d) mm	Packing unit carton/bag	Availability
11122	20	300 / 10	S
11123	25	200 / 10	S
11124	32	80 / 10	S
11125	40	60 / 5	S

PLANNING AND DESIGN

WELDING TECHNOLOGY

## POLYMUTAN welding bend 90°



A. no.	Diameter (d) mm	Packing unit carton/bag	Availability
11082	20	120 / 5	MQ
11083	25	70 / 5	MQ
11084	32	40 / 5	MQ

ASSEMBLY GUIDELINES

## POLYMUTAN welding tee



A. no.	Diameter (d) mm	Packing unit carton/bag	Availability
11202	20	300 / 10	S
11203	25	200 / 10	S
11204	32	100 / 10	S
11205	40	30 / 5	S
11206	50	30 / 2	S
11207	63	10 / 1	S
11208	75	15 / 1	S
11209	90	12 / 1	S
11210	110	6 / 1	S

INITIAL OPERATION

QUALITY MANAGEMENT

# SYSTEM DESCRIPTION

## POLYMUTAN reduced welding tee



A. no.	Diameter (d) mm	Packing unit carton/bag	Availability
11250	25 × 20 × 20	250 / 10	S
11251	20 × 25 × 20	250 / 10	MQ
11254	25 × 20 × 25	250 / 10	S
11256	25 × 25 × 20	250 / 10	MQ
11261	32 × 20 × 20	120 / 5	MQ
11266	32 × 25 × 20	120 / 5	MQ
11267	32 × 20 × 25	120 / 5	MQ
11269	32 × 25 × 25	120 / 5	MQ
11273	32 × 20 × 32	120 / 5	S
11275	32 × 25 × 32	120 / 5	S
11301	40 × 32 × 32	80 / 5	MQ
11305	40 × 20 × 40	80 / 5	S
11307	40 × 25 × 40	80 / 5	S
11309	40 × 32 × 40	80 / 5	S
11311	50 × 20 × 50	40 / 2	MQ
11334	50 × 25 × 50	40 / 2	S
11336	50 × 32 × 50	40 / 2	S
11338	50 × 40 × 50	40 / 2	S
11340	63 × 20 × 63	25 / 1	S
11352	63 × 25 × 63	25 / 1	S
11354	63 × 32 × 63	25 / 1	S
11356	63 × 40 × 63	25 / 1	S
11358	63 × 50 × 63	25 / 1	S
11370	75 × 25 × 75	15 / 1	S
11372	75 × 32 × 75	15 / 1	S
11374	75 × 40 × 75	15 / 1	S
11376	75 × 50 × 75	15 / 1	S
11378	75 × 63 × 75	15 / 1	S
11394	90 × 50 × 90	12 / 1	MQ
11396	90 × 63 × 90	12 / 1	S
11398	90 × 75 × 90	8 / 1	S
11414	110 × 63 × 110	14 / 1	S
11416	110 × 75 × 110	6 / 1	S
11418	110 × 90 × 110	6 / 1	S

## POLYMUTAN assembly group



A. no.	Diameter (d) mm	Packing unit carton/bag	Availability
14704	20 × 1/2" IG	1	MQ

SYSTEM DESCRIPTION

TRANSPORTATION AND STORAGE

DRINKING WATER HYGIENE

SYSTEM REQUIREMENTS

PLANNING AND DESIGN

WELDING TECHNOLOGY

ASSEMBLY GUIDELINES

INITIAL OPERATION

QUALITY MANAGEMENT

# SYSTEM DESCRIPTION

SYSTEM DESCRIPTION  
TRANSPORTATION AND STORAGE  
DRINKING WATER HYGIENE  
SYSTEM REQUIREMENTS  
PLANNING AND DESIGN  
WELDING TECHNOLOGY  
ASSEMBLY GUIDELINES  
INITIAL OPERATION  
QUALITY MANAGEMENT

## POLYMUTAN weld-in saddle with welding sleeve



A. no.	Diameter (d) mm	Packing unit carton/bag	Availability
11741	40 / 20	250 / 5	S
11742	40 / 25	250 / 5	S
11744	50 / 20	250 / 5	S
11745	50 / 25	250 / 5	S
11747	63 / 20	200 / 5	S
11748	63 / 25	200 / 5	S
11749	63 / 32	150 / 5	S
11750	75 / 20	200 / 5	S
11751	75 / 25	200 / 5	S
11752	75 / 32	120 / 5	S
11754	90 / 20	200 / 5	S
11756	90 / 25	200 / 5	S
11758	90 / 32	150 / 5	S
11760	110 / 20	200 / 5	S
11761	110 / 25	150 / 5	S
11762	110 / 32	120 / 5	S

Tools see page 32

## POLYMUTAN weld-in saddle with an internal screw thread for wrench – female



A. no.	Diameter (d) mm	Packing unit carton/bag	Availability
12352	40 × 1/2"	100 / 5	S
12353	40 × 3/4"	100 / 5	S
12354	50 × 1/2"	100 / 5	S
12355	50 × 3/4"	100 / 5	S
12356	63 × 1/2"	100 / 5	S
12357	63 × 3/4"	50 / 5	S
12358	63 × 1"	50 / 5	S
12359	75 × 1/2"	80 / 5	S
12360	75 × 3/4"	80 / 5	S
12361	75 × 1"	50 / 5	S
12362	90 × 1/2"	80 / 5	S
12363	90 × 3/4"	80 / 5	S
12364	90 × 1"	50 / 5	S
12366	110 × 1/2"	100 / 5	S
12367	110 × 3/4"	80 / 5	S
12368	110 × 1"	50 / 5	S

Tools see page 32

## POLYMUTAN end cap



A. no.	Diameter (d) mm	Packing unit carton/bag	Availability
11702	20	400 / 10	S
11703	25	250 / 10	S
11704	32	150 / 10	S
11705	40	100 / 5	S
11706	50	60 / 5	S
11707	63	30 / 1	S
11708	75	20 / 1	S
11709	90	30 / 1	S
11710	110	15 / 1	S

# SYSTEM DESCRIPTION

<b>POLYMUTAN flange bushing with gasket</b> 	A. no.	Diameter (d) mm	Packing unit carton/bag	Availability
	11807	63	30 / 1	MQ
	11808	75	20 / 1	S
	11809	90	15 / 1	S
	11810	110	12 / 1	S





<b>PP-flange, glass fibre reinforced with steel insert, for flange bushing POLYMUTAN PN 16</b> 	A. no.	Diameter (d) mm	DN	Packing unit carton/bag	Availability
	14207	63	50	1	S
	14208	75	65	1	S
	14209	90	80	1	S
	14210	110	100	1	S

<b>Electro socket</b> Colour: Green SDR 7.4 Welding voltage: 8–48 V Pin size: 4 mm With bar code Suitable welding tool A. no. 15270 	A. no.	Diameter (d) mm	Packing unit carton/bag	Availability
	14802	20	35 / 1	S
	14803	25	25 / 1	S
	14804	32	20 / 1	S
	14805	40	25 / 1	S
	14806	50	20 / 1	S
	14807	63	25 / 1	S
	14808	75	36 / 1	S
	14809	90	18 / 1	S
	14810	110	15 / 1	S

## 1.3.3 POLYMUTAN Adapters

<b>POLYMUTAN adapter female thread</b> Material: PP-R/brass Colour: curry Standards: EN ISO 15874 Product line: Ø 20–75 mm Processing: Socket welding  Type A                      Type B 	A. no.	Diameter (d) mm	Type	Packing unit carton/bag	Availability
	12104	20 × 1/2"	A	130 / 10	S
	12105	20 × 3/4"	A	100 / 10	MQ
	12106	25 × 1/2"	A	130 / 10	S
	12107	25 × 3/4"	A	100 / 10	S
	12108	32 × 3/4"	A	100 / 10	S
	12109	32 × 1"	B	50 / 5	S
	12110	40 × 1"	B	50 / 5	MQ
	12111	40 × 1 1/4"	B	30 / 5	S
	12112	50 × 1 1/2"	B	25 / 5	S
	12113	63 × 2"	B	10 / 1	S
	12115	75 × 2"	B	8 / 1	MQ
	12116	75 × 2 1/2"	B	8 / 1	S

# SYSTEM DESCRIPTION

SYSTEM DESCRIPTION	<b>POLYMUTAN adapter male thread</b>					
	Material: PP-R/brass					
	Colour: Curry					
	Standards: EN ISO 15874					
	Product line: Ø 20–110 mm					
	Processing: Socket welding					
	Type A		Type B			
						
	TRANSPORTATION AND STORAGE	A. no.	Diameter (d) mm	Type	Packing unit carton/bag	Availability
		12154	20 × 1/2"	A	100 / 10	S
		12155	20 × 3/4"	A	100 / 10	MQ
		12156	25 × 1/2"	A	100 / 10	S
		12157	25 × 3/4"	A	100 / 10	S
12158		32 × 3/4"	A	80 / 5	S	
12159		32 × 1"	B	50 / 5	S	
12160		40 × 1"	B	50 / 5	MQ	
12161		40 × 1 1/4"	B	30 / 5	S	
12162		50 × 1 1/4"	B	20 / 5	MQ	
12163		50 × 1 1/2"	B	20 / 5	S	
12165		63 × 2"	B	20 / 1	S	
DRINKING WATER HYGIENE		12167	75 × 2 1/2"	B	8 / 1	S
	12169	90 × 3"	B	6 / 1	S	
	12172	110 × 3"	B	4 / 1	S	
	<b>POLYMUTAN elbow adapter female from 1" for wrench</b>					
						
SYSTEM REQUIREMENTS	A. no.	Diameter (d) mm	Packing unit carton/bag	Availability		
	12204	20 × 1/2"	150 / 10	S		
	12205	20 × 3/4"	100 / 10	MQ		
	12206	25 × 1/2"	120 / 10	S		
	12207	25 × 3/4"	100 / 10	S		
	12208	32 × 3/4"	70 / 5	S		
PLANNING AND DESIGN	<b>POLYMUTAN elbow adapter male/female</b>					
						
WELDING TECHNOLOGY	A. no.	Diameter (d) mm	Packing unit carton/bag	Availability		
	12234	20 × 1/2"	100 / 10	S		
ASSEMBLY GUIDELINES	<b>POLYMUTAN elbow adapter male from 1" for wrench</b>					
						
	A. no.	Diameter (d) mm	Packing unit carton/bag	Availability		
	12254	20 × 1/2"	100 / 10	S		
	12255	20 × 3/4"	100 / 10	MQ		
	12256	25 × 1/2"	100 / 10	S		
	12257	25 × 3/4"	70 / 10	S		
12258	32 × 3/4"	70 / 5	MQ			
12259	32 × 1"	40 / 5	S			
INITIAL OPERATION						
QUALITY MANAGEMENT						



# SYSTEM DESCRIPTION

<b>POLYMUTAN tee adapter female from 1" for wrench</b>	A. no.	Diameter (d) mm	Packing unit carton/bag	Availability
	12304	20 × 1/2" × 20	100 / 10	S
	12306	25 × 1/2" × 25	80 / 10	S
	12307	25 × 3/4" × 25	70 / 10	S
	12309	32 × 1" × 32	30 / 5	S
	12310	32 × 3/4" × 32	40 / 5	S
	12311	32 × 1/2" × 32	40 / 5	S
	12312	40 × 3/4" × 40	30 / 5	MQ
	12313	40 × 1" × 40	30 / 5	MQ
	12314	50 × 1" × 50	20 / 5	MQ

  

<b>POLYMUTAN screw adapter pipe end/pipe end</b>	A. no.	Diameter (d) mm	Packing unit carton/bag	Availability
	14182	20	80 / 1	MQ
	14183	25	50 / 1	MQ
	14184	32	50 / 1	MQ
	14185	40	25 / 1	MQ
	14186	50	20 / 1	MQ
	14187	63	15 / 1	MQ

<b>POLYMUTAN screw adapter, male, thread/pipe end</b>	A. no.	Diameter (d) mm	Packing unit carton/bag	Availability
	14172	20 × 1/2"	80 / 1	MQ
	14173	25 × 3/4"	50 / 1	S
	14174	32 × 1"	50 / 1	MQ
	14175	40 × 1 1/4"	25 / 1	MQ
	14176	50 × 1 1/2"	20 / 1	MQ
	14177	63 × 2"	15 / 1	MQ

<b>POLYMUTAN screw adapter, female, thread/pipe end</b>	A. no.	Diameter (d) mm	Packing unit carton/bag	Availability
	14162	20 × 1/2"	80 / 1	MQ
	14163	25 × 3/4"	50 / 1	MQ
	14164	32 × 1"	50 / 1	MQ
	14165	40 × 1 1/4"	25 / 1	MQ
	14166	50 × 1 1/2"	20 / 1	MQ
	14167	63 × 2"	15 / 1	MQ

SYSTEM DESCRIPTION
TRANSPORTATION AND STORAGE
DRINKING WATER HYGIENE
SYSTEM REQUIREMENTS
PLANNING AND DESIGN
WELDING TECHNOLOGY
ASSEMBLY GUIDELINES
INITIAL OPERATION
QUALITY MANAGEMENT

# SYSTEM DESCRIPTION

SYSTEM DESCRIPTION

## POLYMUTAN screwed union plastic/brass F with socket end



A. no.	Diameter (d) mm	Packing unit carton/bag	Availability
14043	20 × 1/2"	100 / 1	S
14045	20 × 3/4"	100 / 1	MQ
14047	25 × 3/4"	100 / 1	S
14048	25 × 1"	70 / 1	MQ
14050	32 × 1"	70 / 1	S
14051	32 × 1 1/4"	50 / 1	MQ
14053	40 × 1 1/4"	50 / 1	S
14054	40 × 1 1/2"	40 / 1	MQ
14056	50 × 1 1/2"	30 / 1	S
14058	63 × 2"	20 / 1	S

TRANSPORTATION AND STORAGE

DRINKING WATER HYGIENE

## 1.3.4 POLYMUTAN fittings and accessories

SYSTEM REQUIREMENTS

### POLYMUTAN wall union, female



A. no.	Diameter (d) mm	Packing unit carton/bag	Availability
12004	20 × 1/2"	100 / 10	S
12005	25 × 3/4"	80 / 10	MQ
12006	25 × 1/2"	80 / 10	S
12007	25 × 3/4"	80 / 10	S

PLANNING AND DESIGN

### POLYMUTAN wall union passage, female



A. no.	Diameter (d) mm	Packing unit carton/bag	Availability
12024	20 × 1/2"	70 / 10	S
12026	25 × 1/2"	50 / 10	S

WELDING TECHNOLOGY

### POLYMUTAN wall union plate, female distances 150 mm





A. no.	Diameter (d) mm	Packing unit carton/bag	Availability
12034	20 × 1/2"	1	S
12036	25 × 1/2"	1	S

ASSEMBLY GUIDELINES

INITIAL OPERATION

QUALITY MANAGEMENT

# SYSTEM DESCRIPTION

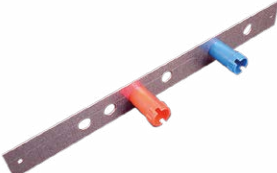
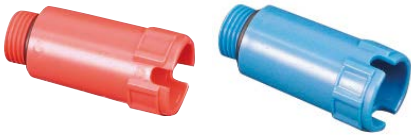
<b>Assembly plate, plastic, with screws for wall union, selectable distances</b> 115/140/150/160/180 mm 	<b>A. no.</b>	<b>Diameter (d) mm</b>	<b>Packing unit carton/bag</b>	<b>Avail-ability</b>		
	15484	250 × 45	50 / 1	S		
<b>Assembly plate, galvanized</b> 	<b>A. no.</b>	<b>Diameter (d) mm</b>	<b>Supply unit card-board box/package</b>	<b>Avail-ability</b>		
	15480	2000 × 50 × 3	25 / 1	S		
<b>Assembly unit, galvanized, for wall union, with screws</b> Distance 150/80 mm 	<b>A. no.</b>	<b>Diameter (d) mm</b>	<b>Supply unit card-board box/package</b>	<b>Avail-ability</b>		
	15482	420 × 60 × 45	1	S		
<b>Assembly help with 2 plugs, distances</b> 75/85/100/140/150/175 mm 	<b>A. no.</b>	<b>Diameter (d) mm</b>	<b>Packing unit carton/bag</b>	<b>Avail-ability</b>		
	15400	1/2"	20/1	S		
<b>Assembly plug</b> Material: PP-R Colour: Blue, Red Product line: Ø 1/2" 	<b>A. no.</b>	<b>Diameter (d) mm</b>	<b>Colour</b>	<b>Weight kg/pc.</b>	<b>Packing unit carton/bag</b>	<b>Avail-ability</b>
	15413	1 / 2"	Red	0.022	200 / 10	S
	15414	1 / 2"	Blue	0.022	200 / 10	S

SYSTEM DESCRIPTION

TRANSPORTATION AND STORAGE

DRINKING WATER HYGIENE

SYSTEM REQUIREMENTS

PLANNING AND DESIGN

WELDING TECHNOLOGY







ASSEMBLY GUIDELINES

INITIAL OPERATION

QUALITY MANAGEMENT

# SYSTEM DESCRIPTION

## 1.3.5 POLYMUTAN Shut-off devices and accessories

SYSTEM DESCRIPTION	<b>POLYMUTAN slanted seat valve, body</b> without discharge screw					
	A. no.	Diameter (d) mm	Packing unit carton/bag	Availability		
TRANSPORTATION AND STORAGE		14504	20 × 3/4"	50 / 5	S	
		14505	25 × 3/4"	50 / 5	S	
		14508	32 × 1"	25 / 5	S	
		14510	40 × 1 1/4"	15 / 1	S	
		14512	50 × 1 1/2"	10 / 1	MQ	
DRINKING WATER HYGIENE	<b>Slanted seat valve, upper part</b>					
	A. no.	Diameter (d) mm	Packing unit carton/bag	Availability		
SYSTEM REQUIREMENTS		without backflow prevention and non-rising spindle				
		14642	3/4"	70 / 1	S	
		14643	1"	50 / 1	S	
		14644	1 1/4"	25 / 1	S	
		14645	1 1/2"	25 / 1	S	
	PLANNING AND DESIGN		with backflow prevention and non rising spindle			
			14662	3/4"	25 / 1	S
			14663	1"	40 / 1	S
			14664	1 1/4"	20 / 1	S
			14665	1 1/2"	20 / 1	S
WELDING TECHNOLOGY	<b>POLYMUTAN shut-off valve, body</b> without discharge screw					
	A. no.	Diameter (d) mm	Packing unit carton/bag	Availability		
ASSEMBLY GUIDELINES		14304	20 × 3/4"	50 / 5	S	
		14306	25 × 3/4"	50 / 5	S	
		14308	32 × 1"	30 / 5	S	
INITIAL OPERATION		with discharge screw				
		14324	20 × 3/4"	50 / 5	MQ	
		14326	25 × 3/4"	50 / 5	MQ	
QUALITY MANAGEMENT		<b>Shut-off valve, upper part</b>				
		A. no.	Diameter (d) mm	Packing unit carton/bag	Availability	
		14602	3/4"	125 / 1	S	
	14604	1"	75 / 1	S		
	14606	1 1/4"	40 / 1	S		

# SYSTEM DESCRIPTION

<b>Concealed valve, upper part</b> in flexible length 60–110 mm 	A. no.	Diameter (d) mm	Supply unit card-board box/package	Availability
	14612	3/4"	50 / 1	S
	14614	1"	50 / 1	S

<b>Concealed valve, upper part</b> 	A. no.	Diameter (d) mm	Supply unit card-board box/package	Availability
	14611	3/4"	40 / 1	S
	14617	1"	40 / 1	S

<b>Concealed valve, upper part, public authority design</b> 	A. no.	Diameter (d) mm	Supply unit card-board box/package	Availability
	14622	3/4"	60 / 1	S
	14628	1"	40 / 1	S

<b>POLYMUTAN ball valve</b> Handle: glass fibre reinforced polyamide, ball and stem: brass, PTFE seats: NBR O-ring 	A. no.	Diameter (d) mm	Packing unit carton/bag	Availability
	14402	20	50/5	S
	14403	25	25/5	S
	14404	32	15/1	S
	14405	40	10/1	S
	14412	50	6/1	S
	14414	63	5/1	S
	14416	75	5/1	MQ

## 1.3.6 POLYMUTAN welding machines, tools and accessories

<b>Socket welding machine up to Ø 63 mm "professional"</b> Working range: max. Ø 20–63 mm Power supply: 230 V–50/60 Hz Absorbed power: 800 W Working temperature: TFE 260 °C ± 10 °C Without welding tools 	A. no.	Diameter (d) mm	Weight kg/pc.	Supply unit card-board box/package	Availability
	15016	20–63	1.820	1	S

# SYSTEM DESCRIPTION

SYSTEM DESCRIPTION

## Socket welding machine up to Ø 63 mm "basic"

Working range: max. Ø 20–63 mm  
 Power supply: 230 V–50/60 Hz  
 Absorbed power: 500 W  
 Working temperature: TFE 260 °C ± 10 °C  
 Without welding tools

A. no.	Diameter (d) mm	Weight kg/pc.	Supply unit card-board box/package	Availability
15025	20–63	1.440	1	S



TRANSPORTATION AND STORAGE

DRINKING WATER HYGIENE

## Socket welding machine up to Ø 125 mm

Working range: max. Ø 20–125 mm  
 Power supply: 230 V–50/60 Hz  
 Absorbed power: 1,400 W  
 Working temperature: TFE 260 °C ± 10 °C  
 Without welding tools

A. no.	Diameter (d) mm	Weight kg/pc.	Supply unit card-board box/package	Availability
15015	20–125	3.160	1	S



SYSTEM REQUIREMENTS

PLANNING AND DESIGN

## Socket welding machine for pipes from 40 to 125 mm

Product line: Ø 40–125 mm  
 Processing: Socket welding

A. no.	Weight kg/pc.	Supply unit card-board box/package	Availability
15205	50	1	S



WELDING TECHNOLOGY

ASSEMBLY GUIDELINES

## Welding gauge

Material: PP-R  
 Colour: Green  
 Product line: Ø 20–125 mm  
 For marking the welding depth on the pipe

A. no.	Weight kg/pc.	Supply unit card-board box/package	Availability
15030	0.0056	700 / 50	S



INITIAL OPERATION

QUALITY MANAGEMENT

# SYSTEM DESCRIPTION

<b>Welding machine for electric fittings</b> Working range: 20–315 mm Power supply: 230 V single phase 50/60 Hz Universal adapter: 4.0–4.7 mm Laser scanner For fittings from 8–48 V	A. no.	Weight kg/pc.	Supply unit cardboard box/package	Availability
	15270	25.0	1	S



<b>Rotational pipe scraper</b> Professional rotary scrapers, essential to prepare the plastic pipes and fittings before electro-fusion welding  Peeling depth: 0.2 mm (0.15–0.25 mm)	A. no.	Working range	Weight kg/pc.	Supply unit cardboard box/package	Availability
	15167	20–125	1.100	1	S



<b>Cleaning towels for welded plastic joints</b> 1 can = 100 towels Ingredient: Ethanol	A. no.	Weight kg/pc.	Supply unit cardboard box/package	Availability
	15163	-	1	S



<b>Welding set “BASIC 40” with metal case</b> Working range: max. Ø 20–63 mm Power supply: 230 V–50/60 Hz Absorbed power: 500 W With welding tools 20–40 mm	A. no.	Diameter (d) mm	Weight kg/pc.	Packing unit carton/bag	Availability
	21310	20–63	-	1	S



SYSTEM DESCRIPTION
TRANSPORTATION AND STORAGE
DRINKING WATER HYGIENE
SYSTEM REQUIREMENTS
PLANNING AND DESIGN
WELDING TECHNOLOGY
ASSEMBLY GUIDELINES
INITIAL OPERATION
QUALITY MANAGEMENT



# SYSTEM DESCRIPTION

SYSTEM DESCRIPTION

## Welding set "Professional 63" with metal case

Working range: max. Ø 20–63 mm  
Power supply: 230 V–50/60 Hz  
Absorbed power: 800 W  
With welding tools 20–63 mm and pipe cutter

A. no.	Diameter (d) mm	Weight kg/pc.	Packing unit carton/bag	Availability
15311	20–63	-	1	S



TRANSPORTATION AND STORAGE

DRINKING WATER HYGIENE

## Assembly tool "Spider"

Universal-purpose welding aid for socket welding from 63–125 mm

A. no.	Diameter (d) mm	Weight kg/pc.	Packing unit carton/bag	Availability
15212	63–125	6.800	1	S



SYSTEM REQUIREMENTS

## Pipe cutter for pipes from Ø 20 to 40 mm

Material: Metal  
Colour: Yellow

A. no.	Diameter (d) mm	Weight kg/pc.	Packing unit carton/bag	Availability
15001	20–40	0.460	1	S



PLANNING AND DESIGN

WELDING TECHNOLOGY

## Pipe cutter for pipes from Ø 20 to 63 mm

Material: Metal  
Colour: Yellow

A. no.	Diameter (d) mm	Weight kg/pc.	Packing unit carton/bag	Availability
15003	20–63	1.240	1	S



ASSEMBLY GUIDELINES

INITIAL OPERATION

## Pipe cutter for pipes from Ø 50 to 110 mm

Material: Metal  
Range of application: for pipes SDR 6/7.4/11

A. no.	Diameter (d) mm	Weight kg/pc.	Supply unit cardboard box/package	Availability
15007	50–110	2.0	1	S



QUALITY MANAGEMENT

# SYSTEM DESCRIPTION

<b>Welding attachment</b> Material: Aluminium, teflon-coated Standards: according to DVS, type A Product line: Ø 20–125 mm Processing: Socket welding	A. no.	Diameter (d) mm	Weight kg/pc.	Supply unit card- board box/package	Avail- ability
	15042	20	0.100	1	S
15043	25	0.166	1	S	
15044	32	0.213	1	S	
15045	40	0.268	1	S	
15046	50	0.268	1	S	
15047	63	0.430	1	S	
15048	75	0.668	1	S	
15049	90	0.880	1	S	
15050	110	1.230	1	S	



<b>Hole saw for weld-in saddles</b> Material: Metal  For installation holes and continuous drilling A. no. 15094 necessary	A. no.	Diameter (d) mm	Weight kg/pc.	Supply unit card- board box/package	Avail- ability
	15095	25	-	1	S
15096	32	-	1	S	
15097	40	-	1	S	
15098	50	-	1	S	
15099	63	-	1	S	



<b>Quick change system</b> With pilot drill for hole saw, bayonet catch, quick change between hole saws of different diameters	A. no.	for A. no.
		15094



<b>Welding tools for weld-in saddle</b> Material: Aluminium, teflon-coated Product line: Ø 40–250 mm Processing: Socket welding	A. no.	Diameter (d) Pipe/outlet mm	Bore dia- meter mm	Weight kg/pc.	Supply unit card- board box/package	Avail- ability
	15065	40	25	0.225	1	S
15066	50	25	0.240	1	S	
15067	63	25	0.240	1	S	
15082	63	32	0.240	1	S	
15068	75	25	0.275	1	S	
15083	75	32	0.280	1	S	
15069	90	25	0.280	1	S	
15084	90	32	0.370	1	S	
15070	110	25	0.300	1	S	
15085	110	32	0.400	1	S	



# SYSTEM DESCRIPTION

SYSTEM DESCRIPTION
TRANSPORTATION AND STORAGE
DRINKING WATER HYGIENE
SYSTEM REQUIREMENTS
PLANNING AND DESIGN
WELDING TECHNOLOGY
ASSEMBLY GUIDELINES
INITIAL OPERATION
QUALITY MANAGEMENT

**Welding attachment**  
for repair of holes up to Ø 8 mm  
Material: Aluminium, Teflon-coated

A. no.	Diameter (d) mm	Weight kg/pc.	Supply unit card-board box/package	Availability
15080	8	0.169	1	S



**POLYMUTAN welding plug**  
for repair of holes up to Ø 8 mm

A. no.	Diameter (d) mm	Weight kg/pc.	Supply unit card-board box/package	Availability
21090	–	0.003	1200 / 100	S



# TRANSPORTATION AND STORAGE

## 2.1 Safety instructions and intended use

- Carefully read the Technical Manual and the Operating Instructions before starting work.
- POLYMELT Installation Systems may only be planned, assembled and started up as described in the present manual.
- For any deviating fields of application, make sure to obtain POLYMELT'S advice.
- All national and international safety regulations and regulations on accident prevention have to be observed.
- Planning, installation and start-up have to be carried out pursuant to the current directives, standards and regulations, as intended and in accordance with the state of the art.
- Only POLYMELT system components are allowed to be used. The use of other components entails loss of guarantee (refer to the Letter of Guarantee on page 93).
- Observe the general safety regulations when handling assembly tools. Danger of burn.

### Handling instructions

- POLYMELT PP-R / PP-RCT pipes can generally be stored at any ambient temperature.
- Nevertheless, the material must never be subject to impacts or blows, particularly at temperatures below 5 °C.
- Do not drop the pipes when unloading them and protect them from falling objects.
- Select the place of storage so as to make sure that the pipes are always supported over their entire length.
- Before starting assembly, check the pipe and particularly the pipe ends for cracks or damage.
- Observe cleanliness when storing and laying the pipes and fittings. In order to protect the pipes and fittings against contamination, do not remove the packaging material before the material is used.
- Pipes (except UV pipes) and fittings must not be exposed to UV radiation over prolonged periods as this reduces the durability and the special properties of the pipes; provide protection of the pipes from the outside.
- At temperatures below zero, water supply pipes must be protected from frost, and drained, if necessary.
- Cut the pipes using only sharp tools.



Avoid sharp impacts and blows to the pipes, especially at low temperatures. Do not throw when unloading. Protect pipes from falling objects.



Put down pipes or pipe bundles carefully. Cover pipes in areas of falling rocks, etc.



Do not use cracked or damaged pipes.



Only cut pipes with sharp cutters.



Do not expose pipes to UV-radiation for extended periods of time.



Protect stored pipes from sun and rain.



During polyfusion welding, do not twist the pipe or fitting; push the pipe and fitting joint together in a straight manner.



Minor corrections can only be made during joining.



Protect pipes filled with water from freezing.



Drain lines in danger of freezing.

# DRINKING WATER HYGIENE

## 3.1 Drinking water

Drinking water is our most important comestible, which is why water should always be available in optimum quality. The basic requirements on the quality of drinking water in Germany are defined in the "Drinking Water Ordinance (Trinkwasserverordnung)". To make sure to achieve the required quality parameters, the generally acknowledged codes of practice must also be observed. Drinking water hygiene has always been an important matter, particularly in sensitive buildings such as hospitals or retirement homes. But according to the latest findings, hygiene has also become an important topic for the construction of single- and two-family houses. In this connection, several requirements must be met by the design of drinking water installations. Only specialised companies should be involved in their planning or modification. They know all the relevant technical aspects and are obliged to adhere to them. The dimensional design of the pipe system, the types of materials used, as well as pipe insulation and minimisation of possible water stagnation in the pipes, are of great significance. Materials in contact with the drinking water may transmit undesirable substances to the drinking water. Improper design and assembly of an installation may also further the formation and growth of biofilm, which establishes optimum conditions for the growth of undesirable microorganisms such as legionellae and pseudomonads. They may become a hazard to the occupants' health. Furthermore, the distance of flow up to the tap should be as short as possible. Dead-water sections in which the water flows only rarely or does not flow at all, need to be avoided by all means.



If the influence of all these factors can be minimized as early as at the planning stage, this will make sure that the interior installations also maintain an optimum water quality. Structural components and materials that are in contact with drinking water must not affect it adversely. Planning and assembly of drinking water installations must also ensure that the comestible drinking water is conveyed under perfect hygienic conditions.

**The following lists the most important criteria that need to be observed for perfect planning and assembly of the system and optimum drinking water quality:**

- Avoidance of stagnation
- Operation as intended
- Short connecting lines
- Main consumer at the end of the single-connection line
- Separation of sections that are not in use
- Correct dimensioning
- Hydraulic alignment of circulation systems
- Avoidance of cold water heating up (max. 25 °C)
- Avoidance of hot water cooling down (min. 55 °C)
- Expert initial operation (pressure test, flushing)

# DRINKING WATER HYGIENE

## 3.2 Types of installation

### 3.2.1 Connection of drinking water tapping points

The quality of drinking water provided in an interior installation is entirely dependent on the observance of certain temperature ranges and the avoidance of stagnation. Traditional piping networks make it almost impossible to observe both requirements under the prevailing conditions of use. Therefore, drinking water tapping points are nowadays preferably interconnected in loop lines.

Interconnection of tapping points in a loop line proves to be an effective concept of avoiding stagnating water.

#### Examples of different installation types:

**T-installations** can lead to water stagnating in the lines.

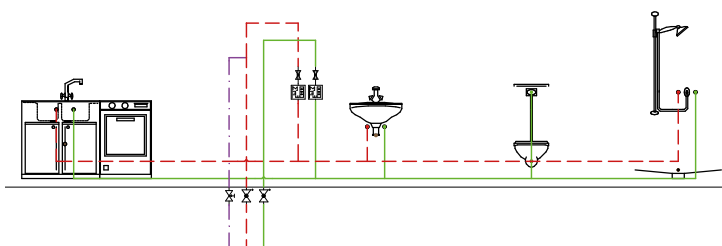

A **loop line** avoids stagnation in a drinking water installation from the very beginning.

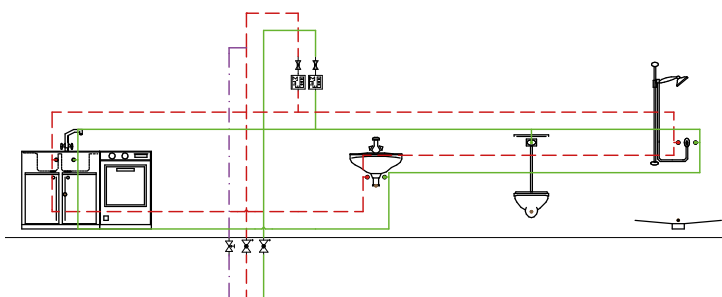

**Serial lines** only make sense, if the last consumer is a frequently used sanitary device.

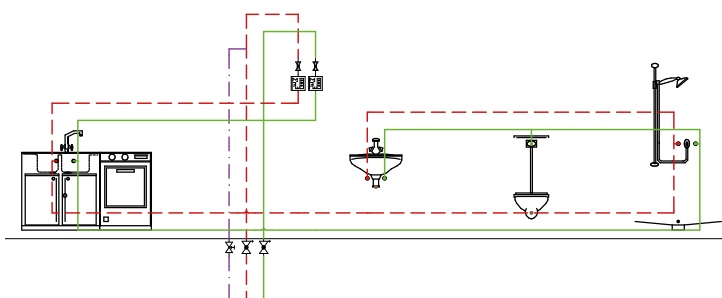

This description is based on directives applicable in Germany and the European Union.

These are the important directives on the quality of water that is intended for consumption by humans:

- Germany: Drinking Water Ordinance (Trinkwasserverordnung TrinkwV2001)
- European Union: Directive on Drinking Water 98/83/EG

Traditional pipe installation, for example, T-systems or floor manifolds for drinking water installation in buildings, frequently causes hygienic problems because of stagnation or inadmissible heating up of cold water. However, if no other way of installation can be used, water contamination should be avoided by forced pipe flushing.

SYSTEM DESCRIPTION

TRANSPORTATION AND STORAGE

DRINKING WATER HYGIENE

SYSTEM REQUIREMENTS

PLANNING AND DESIGN

WELDING TECHNOLOGY

ASSEMBLY GUIDELINES

INITIAL OPERATION

QUALITY MANAGEMENT

# SYSTEM REQUIREMENTS

## 4.1 Standards and regulations

The following standards and guidelines are relevant for planning, design and operating drinking water installation systems in Germany and have to be observed.

### 4.1.1 Planning of drinking water installation systems

EnEV	German Energy Saving Regulation
DIN 1988	Technical Regulations on Drinking Water Installations
DIN EN 806	Technical Regulations on Drinking Water Installations
DIN 2000	Guidelines on the Requirements on Drinking Water, Planning, Laying, Operation and Maintenance of Supply Systems
DIN 4109	Sound Protection in Structural Engineering
DIN 4102	Fire Prevention
DVGW W 551	Technical Measures for the Reduction of Legionella Growth in Drinking Water Installations
VDI 6023	Hygiene-conscious planning, laying, operation and maintenance of drinking water plants
POLYMELT	Technical Manual
DVS 2207	Welding of Thermoplastics
DVS 2208	Machinery and Appliances for Welding Thermoplastics

### 4.1.2 System-specific standards

DIN EN ISO 15874	Parts 1-7	Plastics piping systems for hot and cold water installations – Polypropylene (PP)
	Part 1	General information
	Part 2	Pipes
	Part 3	Fittings
	Part 5	Fitness for purpose of the system
	Part 7 / TS	Conformity Assessment
DIN 8077		Polypropylene Pipe Systems, Dimensions
DIN 8078		Polypropylene Pipe Systems
		General Quality Requirements, Testing
DIN EN ISO 21003	Parts 1-7	Multilayer Composite Pipe Systems for Hot and Cold Water Installations within Buildings

#### Hygiene

DVGW W 270	Growth of Microorganisms on Materials used in Drinking Water Installations - Tests and Assessment
KTW	Guideline of the Federal Environmental Agency on the Assessment of Organic Materials in Contact with Drinking Water

DIN standards are similar to ISO standards. The ISO standards are valid all over the world, while DIN standards only apply in Germany. ISO stands for the International Standardisation Organisation, which is an Association of Standards Organisations of more than 150 countries. Lately, no clear dividing line between standards seems to exist. For example, an ISO standard can be directly transferred to a DIN standard, or a German standard can be filed with the international committee as a pre-standard, which is why parallelisms exist between standards.



# SYSTEM REQUIREMENTS

## 4.2 Terms used

### 4.2.1 Standard dimension ratio

SDR is an index in use for the classification of plastic pipes, which describes the ratio between a pipe's outer diameter and its wall thickness.

$$\text{SDR} = 2 \cdot S + 1 \quad \text{SDR} \approx \frac{d_a}{s}$$

S = pipe series number  
s = wall thickness  
da = outer diameter

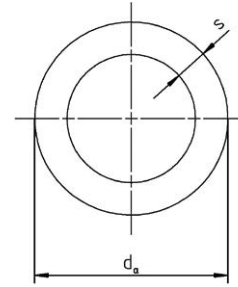

### 4.2.2 Pipe series number S

The nominal pipe series number is a dimensionless index, which is used for the calculation of the wall thickness of pipes.

The following equation is used for the calculation of the pipe series number S:

$$S = \frac{\text{SDR} - 1}{2}$$

Example: POLYMUTAN Pipe SDR 6 = S 2.5

### 4.2.3 Nominal pressure (PN)

The abbreviation PN (nominal pressure) indicates a reference value that is representative for a pipe system. This reference value was used in the first plastic pipe standards (for example, DIN 8077 -1974/1989) and was based on a safety factor of 2.0. The maximum working pressure of 20 bar, 16 bar, 10 bar only refers to a service life of 50 years at a working temperature of 20 °C. However, the maximum working pressure is lower for higher temperatures.

This circumstance frequently leads to confusion.

For an exact pipe classification under various operating conditions, newer versions of the respective standards (DIN 8077 – 1999 or EN ISO 15874 – 2003) therefore only state the pipe series S or the diameter-wall thickness ratio SDR.

# SYSTEM REQUIREMENTS

## 4.3 Requirements on pipe systems

Standards on the various products (for PP-R: EN ISO 15874), as well as the most recent standard on multilayer pipes (DIN EN ISO 21003) have introduced the term “classification of operating conditions”.

The requirements made on pipe systems over their operating time according to ISO 15874 have been defined for four classes of application and are indicated in Table 1.

An admissible working pressure of 4 bar, 6 bar, 8 bar or, respectively, 10 bar is valid for each of the different classes of application.

All systems that comply with the conditions as stated in Table 1 must be suitable for conveying cold water at 20 °C and an admissible working pressure of 10 bar over a period of 50 years.

Only water or treated water may be used as heat transmitter in heating systems.

### 4.3.1 Classification of operational conditions

Class of application according to DIN EN ISO 15874

Table 1

Class of application	Design temperature $T_D$ °C	Duration of operation <sup>a</sup> at $T_D$ years	$T_{max}$ °C	Duration of operation at $T_{max}$ year(s)	$T_{times}$ °C	Duration of operation at $T_{times}$ h	Typical field of application
1 <sup>a</sup>	60	49	80	1	95	100	Hot water supply (60 °C)
2 <sup>a</sup>	70	49	80	1	95	100	Hot water supply (70 °C)
4 <sup>b</sup>	20 Followed by 40 Followed by 60 Followed by (see next column)	2,5 20 25	70	2.5	100	100	Underfloor heating and low-temperature radiator connection
5 <sup>b</sup>	20 Followed by 60 Followed by 80 Followed by (see next column)	14 25 10	90	1	100	100	High-temperature radiator connection

Annotation: This international standard does not apply, if values that are higher than those stated in the table are taken as a basis for  $T_D$ ,  $T_{max}$  and  $T_{times}$ .

<sup>a</sup> Pursuant to national regulations either class 1 or class 2 may be selected.

<sup>b</sup> If more than one design temperature is obtained for a class of application, the respective operating periods should be added up (for example, the universe of temperatures for class 5 and a duration of 50 years consists of the following:

- 20 °C over 14 years, followed by
- 60 °C over 25 years, followed by
- 80 °C over 10 years, followed by
- 90 °C over 1 years, followed by
- 100 °C over 100 h.)

# SYSTEM REQUIREMENTS

## 4.3.2 Table of working pressure is exposed

Long-term stress behaviour of POLYMELT pipes with a safety factor of 1.25

Temperature	Operating time	POLYMUTAN SDR 6		POLYMUTAN SDR 11		POLYMUTAN ML5 SDR 7.4		UV ML5 SDR 7.4	
		max. Service pressure							
		bar	psi	bar	psi	bar	psi	bar	psi
20 °C	1	36.0	522	18.0	261	31.0	450	28.5	413
	5	33.8	490	16.9	245	29.1	422	26.8	389
	10	32.8	476	16.4	238	28.4	412	26.1	379
	25	31.8	461	16.0	232	27.4	397	25.2	366
	50	30.9	448	15.5	225	26.7	387	24.5	355
30 °C	1	30.6	444	15.3	222	26.4	383	24.2	351
	5	28.7	416	14.4	209	24.8	360	22.7	329
	10	27.7	402	13.9	202	24.1	350	22.1	321
	25	26.8	389	13.4	194	23.3	338	21.3	309
	50	26.1	379	13.1	190	22.6	328	20.7	300
40 °C	1	25.8	374	12.9	187	22.5	326	20.6	299
	5	24.2	351	12.1	176	21.0	305	19.2	279
	10	23.6	342	11.8	171	20.4	296	18.7	271
	25	22.6	328	11.3	164	19.7	286	18.0	261
	50	22.0	319	11.0	160	19.1	277	17.4	252
50 °C	1	22.0	319	11.0	160	19.0	276	17.4	252
	5	20.4	296	10.2	148	17.8	258	16.2	235
	10	19.7	286	9.9	144	17.2	250	15.7	228
	25	19.1	277	9.6	139	16.6	241	15.1	219
	50	18.5	268	9.3	135	16.1	234	14.7	213
60 °C	1	18.5	268	9.3	135	16.1	234	14.7	213
	5	17.2	250	8.6	125	14.9	216	13.6	197
	10	16.6	241	8.3	120	14.5	210	13.2	191
	25	15.9	231	8.0	116	13.9	202	12.7	184
	50	15.3	222	7.7	112	13.5	196	12.3	178
70 °C	1	15.6	226	7.8	113	13.5	196	12.3	178
	5	14.3	207	7.2	104	12.5	181	11.4	165
	10	14.0	203	7.0	102	12.1	176	11.1	161
	25	12.1	176	6.1	88	11.6	168	9.6	139
	50	10.2	148	5.1	74	11.2	162	8.1	117
80 °C	1	13.1	190	6.5	94	11.3	164	10.3	149
	5	11.5	167	5.7	83	10.4	151	9.1	132
	10	9.6	139	4.8	70	10.1	147	7.7	112
	25	7.6	110	3.8	55	9.6	139	6.2	90
95 °C	1	9.2	133	4.6	67	8.6	125	7.3	106
	5	6.2	90	3.1	45	7.9	115	4.9	71
	10	5.2	75	2.6	38	7.6	110	4.2	61

Admissible working pressure values for domestic installations (medium: water according to the Drinking Water Ordinance TrinkwV 2001)

SDR = Standard Dimension Ratio (diameter / wall thickness ratio)

SYSTEM DESCRIPTION
TRANSPORTATION AND STORAGE
DRINKING WATER HYGIENE
SYSTEM REQUIREMENTS
PLANNING AND DESIGN
WELDING TECHNOLOGY
ASSEMBLY GUIDELINES
INITIAL OPERATION
QUALITY MANAGEMENT

# SYSTEM REQUIREMENTS

SYSTEM DESCRIPTION

This table enables you to select the suitable pipe for your application. You should know the requirements made on the system (temperature, pressure).

## Example of how to select a pipe:

TRANSPORTATION AND STORAGE

Field of application: cold water  
Temperature of the medium: 20 °C  
Maximum working pressure: 10 bar

DRINKING WATER HYGIENE

Selection:  
Step 1: select the applicable temperature range > 20 °C  
Step 2: select the required service life > 50 years  
Step 3: maximum working pressure within the system 10 bar > pressure according to the table > 15.5 bar >  
Selection: **POLYMUTAN pipe SDR 11**

SYSTEM REQUIREMENTS

Field of application: hot water  
Temperature of the medium: 70 °C  
Maximum working pressure: 10 bar

Selection:  
Step 1: select the applicable temperature range > 70 °C  
Step 2: select the required service life > 50 years  
Step 3: maximum working pressure within the system 10 bar > pressure according to the table > 11.4 bar >  
Selection: **POLYMUTAN ML5 pipe SDR 7.4**

PLANNING AND DESIGN

Suggestion: pipe for a maximum working pressure of 10 bar  
- cold water 20 °C: POLYMUTAN SDR 11  
- hot water 70 °C: POLYMUTAN ML5 SDR 7.4

WELDING TECHNOLOGY

### 4.3.3 Stress that a pipe system is exposed

When planning and laying pipes, you should always take into account the following interior and exterior stress factors that the pipe system may be exposed to:

#### Factors:

- Temperature (from the inside and the outside)
- Chemical stress
- Pressure (excess and negative)
- Extension (tensile and compression load)
- Exterior loads from underground laying, traffic and heavy structural components

ASSEMBLY GUIDELINES

INITIAL OPERATION

QUALITY MANAGEMENT

# SYSTEM REQUIREMENTS

## 4.4 Chemical resistance

Thanks to the special properties of its materials, the POLYMUTAN installation system features excellent chemical resistance.

Chemical resistance of the POLYMUTAN fittings with brass inserts cannot be put on a level with the resistance of those system elements that are only made of PP-R.

Metallic copper, manganese or cobalt deteriorate the thermal ageing resistance of PP-R, above all, if the plasticized materials come into contact with these metals. Please contact POLYMELT, if the pipe system is likely to come into contact with chemicals and other aggressive media.

### Inquiry regarding the chemical resistance of the POLYMUTAN pipe system

#### Installation company:

<b>Firm</b>	_____
Contact person	_____
Street	_____
Postal code/Place	_____
Telephone	_____
Telefax	_____
<b>Building Project</b>	_____
Street	_____
Place	_____
Place, date	_____

#### Area of application:

<b>Flow medium</b>	_____
°C Service temperature	_____
mbar Service pressure	_____
h/d Running time	_____
<b>Environment</b>	_____
°C Ambient temperature	_____
mbar Ambient pressure	_____

included	not included	<b>Data Sheets</b>
<input type="checkbox"/>	<input type="checkbox"/>	flow medium
<input type="checkbox"/>	<input type="checkbox"/>	environment

Send inquiry to: POLYMELT GmbH  
 Kirnachstraße 17, 87640 Ebenhofen, Germany  
 Tel. +49 8342 70060  
 Fax +49 8342 700666  
 mail@polymelt.com, www.polymelt.com

# SYSTEM REQUIREMENTS

## 4.5 Disinfection

### 4.5.1 Thermal disinfection

In proven cases of contamination, the disinfection of drinking water installations must only be carried out for a limited period of time. Prophylactic disinfection measures do not comply with the minimum quality requirements of the Drinking Water Ordinance. The disinfection of drinking water installations can only be successful, if all sources of contamination have been removed beforehand. The limit values for disinfectant concentration specified in the Drinking Water Ordinance represent maximum values, which were set in accordance with hygienic and toxicological standards. However, no conclusions should be drawn automatically from these values with regard to the resistance of product materials to the disinfectant agents. Only trained specialists may carry out the disinfection of drinking water installations. The disinfection measures must be recorded in writing.

Disinfection measures carried out incorrectly can damage the drinking water installation. A combined thermal-chemical disinfection procedure is not permitted.

**The thermal disinfection of POLYMELT pipe systems must be carried out as follows:**

- The water heater and the entire circulation system must be heated to at least 70 °C.
- Open all draw-off points in succession or line by line.
- Hot water at a temperature of 70 °C must be allowed to run from all draw-off points for at least three minutes.
- Do not allow the temperature to drop during the disinfection process.
- Do not exceed the maximum temperature of 95 °C.
- Take suitable measures to eliminate the risk of scalding.

The total thermal disinfection time for drinking water installations must not exceed 150 hours per year. Longer disinfection times or excessive temperatures can reduce the service life of the drinking water installation and can damage the system.

It might be necessary to carry out thermal disinfection on a regular basis to stop the growth of legionellae. Legionellae are killed at temperatures higher than 55 °C.

<b>Killing times</b>	at 70 °C	3 min.
	at 60 °C	60–120 min.
	at 55 °C	180–240 min.

To provide sufficient disinfection it must be made sure that a temperature level of more than 70 °C is achieved within the entire system.

Provided this type of disinfection is applied on a regular basis and a constant temperature level of more than 65 °C is guaranteed, the PP-RCT is particularly suitable, because of its improved long-term thermal resistance.

SYSTEM DESCRIPTION

TRANSPORTATION AND STORAGE

DRINKING WATER HYGIENE

SYSTEM REQUIREMENTS

PLANNING AND DESIGN

WELDING TECHNOLOGY

ASSEMBLY GUIDELINES

INITIAL OPERATION

QUALITY MANAGEMENT

# SYSTEM REQUIREMENTS

## 4.5.2 Chemical disinfection – “Shock disinfection”

During the process of chemical disinfection (“shock disinfection”) in accordance with Pt. 7.5.2 of the ÖNORM-Standard B 5019, the disinfecting agent can be fed into the cold water circulation or the warm water circulation, respectively. When the disinfecting agent is fed into the warm water circulation, the temperature must first be reduced to below 25 °C. Carrying out “shock disinfections” at higher temperatures is not permissible, as premature material damage cannot be ruled out. In relation to the service life of the installed system, the number of disinfecting procedures must not exceed 5 cycles. No drinking water may be drawn either during the disinfection process or during the subsequent flushing of the system with cold water.

Table 3 lists the concentration and contact times of chemicals on the basis of ÖNORM-Standard B 5019.

Table 3

Active component	Chemical formula	Max. concentration applied	Contact time	Max. water temp. in the system
Chlorine Dioxide	ClO <sub>2</sub>	6 mg/l as ClO <sub>2</sub>	8 to 12 hrs	< 25 °C
Hypochlorite	ClO <sup>-</sup>	50 mg/l as Cl <sub>2</sub> (chlorine)	8 to 12 hrs	< 25 °C
Permanganate	MnO <sub>4</sub> <sup>-</sup>	15 mg/l	24 hrs	< 25 °C
Hydrogen Peroxide	H <sub>2</sub> O <sub>2</sub>	150 mg/l	24 hrs	< 25 °C

Table 3: Concentration and contact times of chemicals for chemical disinfection

During the application the applied concentration and application temperature may not be exceeded at any point within the pipe system.

## 4.5.3 Continuous metered addition of chemicals – “Permanent disinfection”

The continuous metered addition of chemicals according to Pt. 9 of the ÖNORM-Standard B 5019 is only permissible in instances when repeated decontamination processes (thermal, chemical, according to Section 7 of the ÖNORM-Standard) did not produce the desired results and where the systems in question have low levels of biofilm.

It must be stated that the continuous metered addition of chemicals can in no way replace the structural refurbishment of the pipe system and should be regarded merely as temporary supporting measure until such a time as the refurbishment takes place, and not as prophylactic measure against Legionella.

If the timeframe and the maximum water temperature are exceeded, damage to the component parts of the pipe systems (pipe, seals, o-rings, etc.) cannot be ruled out. This applies to all prevalent materials used in plumbing technology (types of metal, plastics and elastomers).

Table 4 lists the concentration and contact times of chemicals on the basis of ÖNORM-Standard B 5019.

Table 4

Active component	Chemical formula	Max. concentration applied	Max. period of application	Max. water temp. in the system
Chlorine Dioxide**	ClO <sub>2</sub>	0.4 mg/l as ClO <sub>2</sub>	4 months	60 °C
Hypochlorite	ClO <sup>-</sup>	0.3 mg/l as Cl <sub>2</sub> (chlorine)	4 months	60 °C
Chlorine	Cl <sub>2</sub>	0.3 mg/l as Cl <sub>2</sub> (chlorine)	4 months	60 °C
Chlorine Dioxide**	ClO <sub>2</sub>	0.4 mg/l as ClO <sub>2</sub>	18 months	< 25 °C
Hypochlorite	ClO <sup>-</sup>	0.3 mg/l as Cl <sub>2</sub> (chlorine)	18 months	< 25 °C
Chlorine	Cl <sub>2</sub>	0.3 mg/l as Cl <sub>2</sub> (chlorine)	18 months	< 25 °C

Table 4: Concentration and contact times of chemicals for continuous metered addition

\*\* For the disinfection process using chlorine dioxide (listed as ClO<sub>2</sub>) the maximum amount that can be added into the pipe system is 0.4 mg/l ClO<sub>2</sub>.

# SYSTEM REQUIREMENTS

## 5.1 Dimensioning of drinking water systems

### 5.1.1 Differentiating calculation procedure

Planning and construction of drinking water installations are based the DIN EN 806 standard or relevant national collateral standards such as DIN 1988-300. These define the procedure used to determine the pipe diameters, which is achieved by calculating the loss of pressure in the pipe system. The pressure loss depends on the pipe length, pipe material, the type of fittings used, as well as the flow rate, which is influenced by the number and size of taps and fittings.

The following data is required to determine pressure losses and pipe diameters:

- supply pressure or outlet pressure after a pressure-reducing valve or pressure increase
- difference in geodetic altitude
- pressure loss related to fittings (e.g., water meters, filters, water softening equipment, etc.)
- minimum flow pressure at the tapping points
- loss of pressure due to the resistance of the pipe materials used
- coefficients of losses relating to fittings and connecting elements used

Below, we introduce a simplified calculation (acc. to EN 806) and a differentiating calculation procedure (acc. to DIN 1988) for the determination of the pipe diameters. The choice of alternative methods allows the selection of the most suitable method for the relevant application. The simplified calculation is recommended for small-scale projects and simple drinking water installations. However, in the interest of hygiene, the differentiating calculation procedure is preferable, in order to ensure the precise calculation and dimensioning of the installation.

The model for the differentiating calculation is illustrated in the process depicted below.

#### Determine total flow rates and allocate to relevant sections

Starting from the farthest tapping point and leading to the supply line, the calculated flow rates are added, and the total flow rates are allocated to the corresponding line sections.

#### Determine peak flow rate from the total flow rate

To calculate the pipeline system, all draw-off tapping points are generally assigned to their respective calculated flows. Simultaneous water tapping depends on the type of use (e.g. residential or communal systems).

Generally, it can be assumed that not all taps will be opened at the same time.

For piping installations in residential buildings, the corresponding peak flow rate can be determined using the formula / diagram in DIN 1988 Section 300.

#### Determine pressure difference for pipe resistance and individual resistance values.

Differentiating Calculation Procedure	Simplified Calculation Procedure
Determine pressure loss value from individual resistance values via loss correction values	Calculate total pressure loss from pipe resistance of all segments and compare to available pressure difference
Calculate total pressure loss from pipe friction and individual resistance values, and compare to available pressure difference	If necessary, re-calculate using altered pipe diameters
If necessary, re-calculate using altered pipe diameters	



# PLANNING AND DESIGN

For sound insulation reasons and in order to limit pressure surges, the calculated flow rate must not exceed the values provided below.

Maximum flow rate in accordance with DIN 1988

Table 5

Line section		Maximum calculated flow rate for a duration of	
		≤ 15 min	> 15 min
connecting lines		2 m/s	2 m/s
Supply pipes	pipe sections with pipe valve fittings featuring low pressure loss ( $\zeta < 2.5$ ) *	5 m/s	2 m/s
	pipe sections with pipe valve fittings with higher loss coefficient values **	2.5 m/s	2 m/s

\* e.g. piston slide valves acc. to DIN 3500, ball valves, slanted seat valves acc. to DIN 3502 (starting from DN 20)

\*\* e.g. shut-off valves acc. to DIN 351

## 5.1.2 Minimum flow pressures of tapping points

Standard minimum flow pressure values and calculated flow rates for selected drinking water tapping points

Table 6

Type of drinking water tapping point			Calculated flow for outlet of		
			mixed water*		either cold or hot drinking water
Minimum flow pressure $P_{min}$ bar			volume flow cold l/s	volume flow hot l/s	volume flow l/s
0.5	outlet valves without aerator**	DN 15	–	–	0.30
0.5		DN 20	–	–	0.50
0.5		DN 25	–	–	1.00
1.0	outlet valves with aerator	DN 10	–	–	0.15
1.0		DN 15	–	–	0.15
1.0	shower heads for cleaning showers		0.10	0.10	0.20
1.2	pressure flusher according to DIN 3265, part 1	DN 15	–	–	0.70
1.2	pressure flusher according to DIN 3265, part 1	DN 20	–	–	1.00
0.4	pressure flusher according to DIN 3265, part 1	DN 25	–	–	1.00
1.0	pressure flusher for urinals	DN 15	–	–	0.30
1.0	household dishwasher	DN 15	–	–	0.15
1.0	household washing machine	DN 15	–	–	0.25
1.0	mixers for showers	DN 15	0.15	0.15	–
1.0	mixers for bath tubs	DN 15	0.15	0.15	–
1.0	mixers for kitchen sinks	DN 15	0.07	0.07	–
1.0	mixers for wash basins	DN 15	0.07	0.07	–
1.0	mixers for bidets	DN 15	0.07	0.07	–
1.0	mixer	DN 20	0.30	0.30	–
0.5	cistern according to DIN 19542	DN 15	–	–	0.13
1.0	electric water boiler	DN 15	–	–	0.10***

\* The calculated flow rates for the supply of mixed water are based on a temperature of 15 °C for cold water and 60 °C for heated drinking water.

\*\* For outlet valves without aerator and with threaded hose connection, the pressure loss in the hose assembly (up to a length of 10 m) and in the connected appliance (e.g. lawn sprinkler) is taken into account as a flat rate minimum flow pressure. In this case, the minimum flow pressure increases by 1.0 bar to 1.5 bar.

\*\*\* with fully opened throttle valve.

Annotation: When determining the pipe diameter, draw-off points which are not included in the table as well as valves and fittings of a similar kind with flow rates of fittings or minimum flow pressures that are greater than indicated must be taken into account as per the recommendations of the manufacturer.

# PLANNING AND DESIGN

## 5.1.3 Peak flow rate according to DIN 1988

Simultaneous water tapping depends on the type of use (e.g. in residential buildings, hotels, etc.). Generally, it can be assumed that not all connected taps will be fully open at the same time. Consequently, the cumulative flow can be converted into the peak flow rate.

Determination of the peak flow rate  $V_S$  from the total flow rate  $\Sigma V_R$

Diagram:

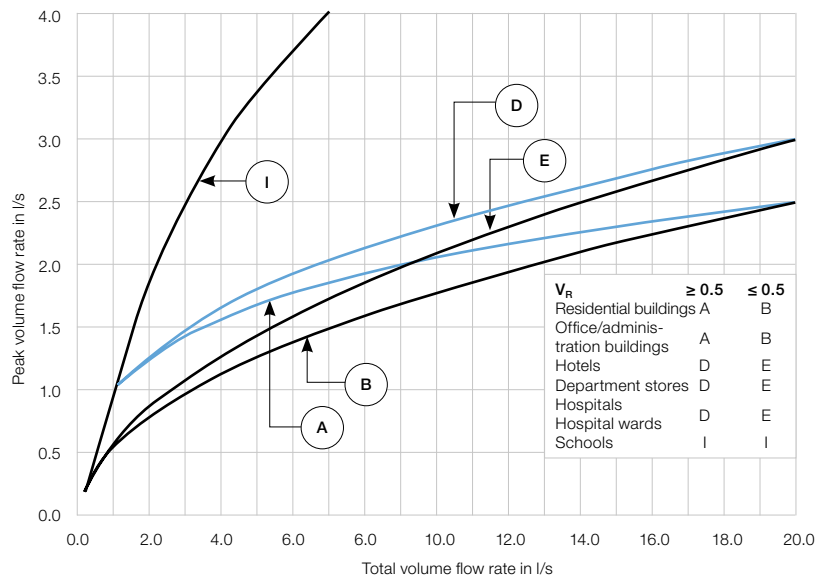

# PLANNING AND DESIGN

**Table 7:**

Values in l/s for residential buildings, offices / administration buildings with an assumed calculated flow rate of the tapping point  $V_R < 0.5$  l/s

Table 7

$\Sigma V_R$	$V_S$	$\Sigma V_R$	$V_S$	$\Sigma V_R$	$V_S$	$\Sigma V_R$	$V_S$	$\Sigma V_R$	$V_S$	$\Sigma V_R$	$V_S$	$\Sigma V_R$	$V_S$	$\Sigma V_R$	$V_S$
0.02	0.02	1.02	0.55	2.02	0.80	3.02	0.98	4.02	1.14	5.10	1.28	10.10	1.79	15.10	2.17
0.04	0.04	1.04	0.55	2.04	0.80	3.04	0.98	4.04	1.14	5.20	1.29	10.20	1.80	15.20	2.18
0.06	0.06	1.06	0.56	2.06	0.80	3.06	0.99	4.06	1.14	5.30	1.30	10.30	1.81	15.30	2.19
0.08	0.08	1.08	0.57	2.08	0.81	3.08	0.99	4.08	1.14	5.40	1.32	10.40	1.82	15.40	2.19
0.10	0.10	1.10	0.57	2.10	0.81	3.10	0.99	4.10	1.15	5.50	1.33	10.50	1.82	15.50	2.20
0.12	0.12	1.12	0.58	2.12	0.82	3.12	1.00	4.12	1.15	5.60	1.34	10.60	1.83	15.60	2.21
0.14	0.14	1.14	0.58	2.14	0.82	3.14	1.00	4.14	1.15	5.70	1.35	10.70	1.84	15.70	2.21
0.16	0.16	1.16	0.59	2.16	0.82	3.16	1.00	4.16	1.16	5.80	1.36	10.80	1.85	15.80	2.22
0.18	0.18	1.18	0.59	2.18	0.83	3.18	1.01	4.18	1.16	5.90	1.38	10.90	1.86	15.90	2.23
0.20	0.19	1.20	0.60	2.20	0.83	3.20	1.01	4.20	1.16	6.00	1.39	11.00	1.87	16.00	2.23
0.22	0.21	1.22	0.61	2.22	0.84	3.22	1.01	4.22	1.16	6.10	1.40	11.10	1.87	16.10	2.24
0.24	0.22	1.24	0.61	2.24	0.84	3.24	1.02	4.24	1.17	6.20	1.41	11.20	1.88	16.20	2.25
0.26	0.23	1.26	0.62	2.26	0.84	3.26	1.02	4.26	1.17	6.30	1.42	11.30	1.89	16.30	2.25
0.28	0.24	1.28	0.62	2.28	0.85	3.28	1.02	4.28	1.17	6.40	1.43	11.40	1.90	16.40	2.26
0.30	0.26	1.30	0.63	2.30	0.85	3.30	1.03	4.30	1.17	6.50	1.44	11.50	1.91	16.50	2.27
0.32	0.27	1.32	0.63	2.32	0.86	3.32	1.03	4.32	1.18	6.60	1.45	11.60	1.91	16.60	2.27
0.34	0.28	1.34	0.64	2.34	0.86	3.34	1.03	4.34	1.18	6.70	1.47	11.70	1.92	16.70	2.28
0.36	0.29	1.36	0.64	2.36	0.86	3.36	1.04	4.36	1.18	6.80	1.48	11.80	1.93	16.80	2.29
0.38	0.30	1.38	0.65	2.38	0.87	3.38	1.04	4.38	1.19	6.90	1.49	11.90	1.94	16.90	2.29
0.40	0.31	1.40	0.65	2.40	0.87	3.40	1.04	4.40	1.19	7.00	1.50	12.00	1.95	17.00	2.30
0.42	0.32	1.42	0.66	2.42	0.88	3.42	1.05	4.42	1.19	7.10	1.51	12.10	1.95	17.10	2.31
0.44	0.33	1.44	0.66	2.44	0.88	3.44	1.05	4.44	1.19	7.20	1.52	12.20	1.96	17.20	2.31
0.46	0.34	1.46	0.67	2.46	0.88	3.46	1.05	4.46	1.20	7.30	1.53	12.30	1.97	17.30	2.32
0.48	0.35	1.48	0.67	2.48	0.89	3.48	1.06	4.48	1.20	7.40	1.54	12.40	1.98	17.40	2.33
0.50	0.36	1.50	0.68	2.50	0.89	3.50	1.06	4.50	1.20	7.50	1.55	12.50	1.99	17.50	2.33
0.52	0.37	1.52	0.68	2.52	0.89	3.52	1.06	4.52	1.20	7.60	1.56	12.60	1.99	17.60	2.34
0.54	0.38	1.54	0.69	2.54	0.90	3.54	1.06	4.54	1.21	7.70	1.57	12.70	2.00	17.70	2.35
0.56	0.39	1.56	0.69	2.56	0.90	3.56	1.07	4.56	1.21	7.80	1.58	12.80	2.01	17.80	2.35
0.58	0.39	1.58	0.70	2.58	0.90	3.58	1.07	4.58	1.21	7.90	1.59	12.90	2.02	17.90	2.36
0.60	0.40	1.60	0.70	2.60	0.91	3.60	1.07	4.60	1.22	8.00	1.60	13.00	2.02	18.00	2.36
0.62	0.41	1.62	0.71	2.62	0.91	3.62	1.08	4.62	1.22	8.10	1.61	13.10	2.03	18.10	2.37
0.64	0.42	1.64	0.71	2.64	0.92	3.64	1.08	4.64	1.22	8.20	1.62	13.20	2.04	18.20	2.38
0.66	0.43	1.66	0.72	2.66	0.92	3.66	1.08	4.66	1.22	8.30	1.63	13.30	2.05	18.30	2.38
0.68	0.43	1.68	0.72	2.68	0.92	3.68	1.09	4.68	1.23	8.40	1.64	13.40	2.05	18.40	2.39
0.70	0.44	1.70	0.73	2.70	0.93	3.70	1.09	4.70	1.23	8.50	1.65	13.50	2.06	18.50	2.40
0.72	0.45	1.72	0.73	2.72	0.93	3.72	1.09	4.72	1.23	8.60	1.66	13.60	2.07	18.60	2.40
0.74	0.46	1.74	0.74	2.74	0.93	3.74	1.09	4.74	1.23	8.70	1.67	13.70	2.07	18.70	2.41
0.76	0.46	1.76	0.74	2.76	0.94	3.76	1.10	4.76	1.24	8.80	1.67	13.80	2.08	18.80	2.41
0.78	0.47	1.78	0.74	2.78	0.94	3.78	1.10	4.78	1.24	8.90	1.68	13.90	2.09	18.90	2.42
0.80	0.48	1.80	0.75	2.80	0.94	3.80	1.10	4.80	1.24	9.00	1.69	14.00	2.10	19.00	2.43
0.82	0.48	1.82	0.75	2.82	0.95	3.82	1.11	4.82	1.24	9.10	1.70	14.10	2.10	19.10	2.43
0.84	0.49	1.84	0.76	2.84	0.95	3.84	1.11	4.84	1.25	9.20	1.71	14.20	2.11	19.20	2.44
0.86	0.50	1.86	0.76	2.86	0.95	3.86	1.11	4.86	1.25	9.30	1.72	14.30	2.12	19.30	2.44
0.88	0.50	1.88	0.77	2.88	0.96	3.88	1.12	4.88	1.25	9.40	1.73	14.40	2.12	19.40	2.45
0.90	0.51	1.90	0.77	2.90	0.96	3.90	1.12	4.90	1.25	9.50	1.74	14.50	2.13	19.50	2.46
0.92	0.52	1.92	0.77	2.92	0.96	3.92	1.12	4.92	1.26	9.60	1.75	14.60	2.14	19.60	2.46
0.94	0.52	1.94	0.78	2.94	0.97	3.94	1.12	4.94	1.26	9.70	1.76	14.70	2.15	19.70	2.47
0.96	0.53	1.96	0.78	2.96	0.97	3.96	1.13	4.96	1.26	9.80	1.76	14.80	2.15	19.80	2.47
0.98	0.54	1.98	0.79	2.98	0.97	3.98	1.13	4.98	1.26	9.90	1.77	14.90	2.16	19.90	2.48
1.00	0.54	2.00	0.79	3.00	0.98	4.00	1.13	5.00	1.27	10.00	1.78	15.00	2.17	20.00	2.49

SYSTEM DESCRIPTION
TRANSPORTATION AND STORAGE
DRINKING WATER HYGIENE
SYSTEM REQUIREMENTS
PLANNING AND DESIGN
WELDING TECHNOLOGY
ASSEMBLY GUIDELINES
INITIAL OPERATION
QUALITY MANAGEMENT

# PLANNING AND DESIGN

## 5.1.4 Single resistance values $\zeta$

Coefficient of resistance values for fittings made of PP-R

Table 8

Fitting	Graphic symbol	Remark	Resistance coefficient value $\zeta$
Tee		branching, dividing flow	1.3
		passage for dividing flow	0.3
		counter current for dividing flow	1.4
		branching, merging flow	1.3
		passage for merging flow	2.5
		counter current for merging flow	3.0
Elbow 90°			1.2
Elbow 45°			0.7
Socket			0.25
Reducer		by 1 dimension	0.4
		by 2 dimensions	0.6
		by 3 dimensions	0.7
		more than 4 dimensions	0.9
Wall union			1.7
Double wall union			1.5
Short cross over			1.9
Transition with internal thread			0.5
Transition with internal thread, reduced			0.8
Transition with external thread			0.4
Transition with external thread, reduced			0.8
Transition elbow with thread			1.7
Tee with transition, dividing flow			1.6
Slanted seat valve			3.0
Slanted seat valve with back-flow prevention			3.8
Shut-off valve			7.0
Ball valve			0.4

# PLANNING AND DESIGN

## 5.1.5 Pressure loss tables

Pressure loss due to pipe resistance R and flow rate v depending on flow V

Pipe SDR 6

Temperature 20 °C      Roughness: 0.007 mm      Density: 998.29 kg/m<sup>3</sup>      Kin. viscosity: 1.004E-06 m<sup>2</sup>/s

		Dimension	20 mm	25 mm	32 mm	40 mm	50 mm	63 mm	75 mm	90 mm	110 mm
		Wall thickness	3.4 mm	4.2 mm	5.4 mm	6.7 mm	8.3 mm	10.5 mm	12.5 mm	15.0 mm	18.3 mm
l/s	m <sup>3</sup> /h	R in mbar/m v in m/s									
0.01	0.04	R	0.15	0.05	0.02	0.01					
		v	0.07	0.05	0.03	0.02					
0.02	0.07	R	0.45	0.16	0.05	0.02	0.01				
		v	0.15	0.09	0.06	0.04	0.02				
0.03	0.11	R	0.87	0.30	0.10	0.03	0.01				
		v	0.22	0.14	0.08	0.05	0.03				
0.04	0.14	R	1.39	0.48	0.15	0.05	0.02	0.01			
		v	0.29	0.18	0.11	0.07	0.05	0.03			
0.05	0.18	R	2.02	0.69	0.22	0.08	0.03	0.01			
		v	0.37	0.23	0.14	0.09	0.06	0.04			
0.06	0.22	R	2.74	0.94	0.30	0.10	0.04	0.01	0.01		
		v	0.44	0.28	0.17	0.11	0.07	0.04	0.03		
0.07	0.25	R	3.55	1.21	0.39	0.13	0.05	0.02	0.01		
		v	0.51	0.32	0.20	0.13	0.08	0.05	0.04		
0.08	0.29	R	4.46	1.51	0.48	0.17	0.06	0.02	0.01		
		v	0.58	0.37	0.23	0.14	0.09	0.06	0.04		
0.09	0.32	R	5.45	1.85	0.59	0.20	0.07	0.02	0.01		
		v	0.66	0.42	0.25	0.16	0.10	0.06	0.05		
0.10	0.36	R	6.52	2.21	0.70	0.24	0.08	0.03	0.01	0.01	
		v	0.73	0.46	0.28	0.18	0.11	0.07	0.05	0.04	
0.12	0.43	R	8.92	3.01	0.95	0.33	0.11	0.04	0.02	0.01	
		v	0.88	0.55	0.34	0.22	0.14	0.09	0.06	0.04	
0.14	0.50	R	11.66	3.92	1.23	0.42	0.15	0.05	0.02	0.01	
		v	1.02	0.65	0.40	0.25	0.16	0.10	0.07	0.05	
0.16	0.58	R	14.71	4.93	1.55	0.53	0.18	0.06	0.03	0.01	
		v	1.17	0.74	0.45	0.29	0.18	0.12	0.08	0.06	
0.18	0.65	R	18.07	6.05	1.89	0.65	0.22	0.08	0.03	0.01	0.01
		v	1.32	0.83	0.51	0.32	0.21	0.13	0.09	0.06	0.04
0.20	0.72	R	21.75	7.26	2.27	0.78	0.27	0.09	0.04	0.02	0.01
		v	1.46	0.92	0.57	0.36	0.23	0.14	0.10	0.07	0.05
0.30	1.08	R	44.65	14.77	4.58	1.56	0.53	0.18	0.08	0.03	0.01
		v	2.19	1.39	0.85	0.54	0.34	0.22	0.15	0.11	0.07
0.40	1.44	R	74.89	24.60	7.58	2.56	0.87	0.29	0.13	0.05	0.02
		v	2.92	1.85	1.13	0.72	0.46	0.29	0.20	0.14	0.09
0.50	1.80	R	112.32	36.68	11.24	3.78	1.28	0.43	0.19	0.08	0.03
		v	3.65	2.31	1.42	0.90	0.57	0.36	0.25	0.18	0.12
0.60	2.16	R	156.82	50.97	15.55	5.21	1.76	0.59	0.26	0.11	0.04
		v	4.38	2.77	1.70	1.08	0.68	0.43	0.31	0.21	0.14
0.70	2.52	R	208.34	67.43	20.49	6.85	2.30	0.77	0.34	0.14	0.05
		v	5.12	3.23	1.98	1.26	0.80	0.51	0.36	0.25	0.17
0.80	2.88	R	266.84	86.05	26.05	8.68	2.91	0.97	0.42	0.18	0.07
		v	5.85	3.70	2.27	1.44	0.91	0.58	0.41	0.28	0.19
0.90	3.24	R	332.29	106.80	32.22	10.72	3.58	1.20	0.52	0.22	0.08
		v	6.58	4.16	2.55	1.62	1.03	0.65	0.46	0.32	0.21
1.00	3.60	R	404.65	129.67	39.01	12.94	4.32	1.44	0.63	0.26	0.10
		v	7.31	4.62	2.83	1.80	1.14	0.72	0.51	0.35	0.24
1.10	3.96	R	483.92	154.66	46.40	15.36	5.11	1.70	0.74	0.31	0.12
		v	8.04	5.08	3.12	1.98	1.26	0.79	0.56	0.39	0.26
1.20	4.32	R	570.09	181.75	54.40	17.97	5.97	1.98	0.86	0.36	0.14
		v	8.77	5.54	3.40	2.16	1.37	0.87	0.61	0.42	0.28
1.30	4.68	R	663.13	210.95	62.99	20.77	6.89	2.29	0.99	0.42	0.16
		v	9.50	6.01	3.68	2.34	1.48	0.94	0.66	0.46	0.31
1.40	5.04	R	763.06	242.24	72.18	23.75	7.86	2.61	1.13	0.47	0.18
		v	10.23	6.47	3.97	2.52	1.60	1.01	0.71	0.50	0.33
1.60	5.76	R		311.09	92.33	30.28	10.00	3.31	1.43	0.60	0.23
		v		7.39	4.53	2.88	1.83	1.15	0.81	0.57	0.38
1.80	6.48	R		388.29	114.85	37.56	12.37	4.08	1.76	0.74	0.28
		v		8.32	5.10	3.24	2.05	1.30	0.92	0.64	0.43
2.00	7.20	R		473.81	139.72	45.56	14.97	4.93	2.13	0.89	0.34
		v		9.24	5.67	3.60	2.28	1.44	1.02	0.71	0.47
2.20	7.92	R		567.64	166.93	54.30	17.80	5.85	2.52	1.05	0.40
		v		10.17	6.23	3.96	2.51	1.59	1.12	0.78	0.52
2.40	8.64	R			196.48	63.77	20.85	6.84	2.94	1.22	0.47
		v			6.80	4.32	2.74	1.73	1.22	0.85	0.57

Table 9

# PLANNING AND DESIGN

		Dimension	20 mm	25 mm	32 mm	40 mm	50 mm	63 mm	75 mm	90 mm	110 mm	
		Wall thickness	3.4 mm	4.2 mm	5.4 mm	6.7 mm	8.3 mm	10.5 mm	12.5 mm	15.0 mm	18.3 mm	
	l/s	m³/h										
SYSTEM DESCRIPTION	2.60	9.36	R			228.36	73.96	24.14	7.90	3.40	1.41	0.54
			v			7.37	4.68	2.97	1.88	1.32	0.92	0.61
	2.80	10.08	R			262.57	84.87	27.65	9.04	3.88	1.61	0.61
			v			7.93	5.04	3.20	2.02	1.43	0.99	0.66
	3.00	10.80	R			299.11	96.51	31.38	10.24	4.39	1.82	0.69
			v			8.50	5.40	3.42	2.17	1.53	1.06	0.71
TRANSPORTATION AND STORAGE	3.50	12.60	R			400.59	128.74	41.70	13.56	5.80	2.40	0.91
			v			9.92	6.30	3.99	2.53	1.78	1.24	0.83
	4.00	14.40	R			516.57	165.44	53.41	17.31	7.39	3.05	1.15
			v			11.33	7.20	4.57	2.89	2.04	1.41	0.95
	4.50	16.20	R				206.60	66.50	21.49	9.16	3.78	1.42
			v				8.10	5.14	3.25	2.29	1.59	1.06
	5.00	18.00	R				252.22	80.96	26.09	11.10	4.57	1.72
			v				9.00	5.71	3.61	2.55	1.77	1.18
	5.50	19.80	R				302.28	96.79	31.12	13.22	5.43	2.04
			v				9.90	6.28	3.97	2.80	1.95	1.30
DRINKING WATER HYGIENE	6.00	21.60	R				356.78	113.99	36.57	15.51	6.36	2.39
			v				10.80	6.85	4.33	3.06	2.12	1.42
	6.50	23.40	R					132.56	42.44	17.97	7.36	2.76
			v					7.42	4.69	3.31	2.30	1.54
	7.00	25.20	R					152.49	48.73	20.61	8.43	3.16
			v					7.99	5.05	3.57	2.48	1.65
	7.50	27.00	R					173.78	55.44	23.42	9.57	3.58
			v					8.56	5.41	3.82	2.65	1.77
	8.00	28.80	R					196.43	62.57	26.39	10.77	4.03
			v					9.13	5.77	4.07	2.83	1.89
SYSTEM REQUIREMENTS	8.50	30.60	R					220.43	70.11	29.54	12.04	4.50
			v					9.70	6.14	4.33	3.01	2.01
	9.00	32.40	R					245.80	78.06	32.86	13.38	4.99
			v					10.27	6.50	4.58	3.18	2.13
	9.50	34.20	R						86.43	36.34	14.79	5.51
			v						6.86	4.84	3.36	2.25
PLANNING AND DESIGN	10.00	36.00	R						95.22	40.00	16.26	6.05
			v						7.22	5.09	3.54	2.36
	10.50	37.80	R						104.42	43.82	17.80	6.62
			v						7.58	5.35	3.71	2.48
	11.00	39.60	R						114.03	47.82	19.40	7.21
			v						7.94	5.60	3.89	2.60
	11.50	41.40	R						124.06	51.98	21.07	7.83
			v						8.30	5.86	4.07	2.72
	12.00	43.20	R						134.49	56.31	22.81	8.46
			v						8.66	6.11	4.24	2.84
	12.50	45.00	R						145.34	60.80	24.61	9.12
			v						9.02	6.37	4.42	2.95
WELDING TECHNOLOGY	13.00	46.80	R						156.61	65.47	26.48	9.81
			v						9.38	6.62	4.60	3.07
	13.50	48.60	R						168.28	70.30	28.41	10.52
			v						9.74	6.88	4.77	3.19
	14.00	50.40	R						180.37	75.30	30.41	11.25
			v						10.11	7.13	4.95	3.31
	14.50	52.20	R							80.47	32.48	12.00
			v							7.38	5.13	3.43
	15.00	54.00	R							85.80	34.61	12.78
			v							7.64	5.31	3.54
ASSEMBLY GUIDELINES	16.00	57.60	R							96.97	39.06	14.41
			v							8.15	5.66	3.78
	17.00	61.20	R							108.80	43.78	16.13
			v							8.66	6.01	4.02
	18.00	64.80	R							121.31	48.76	17.94
			v							9.17	6.37	4.25
	19.00	68.40	R							134.47	54.00	19.85
			v							9.68	6.72	4.49
INITIAL OPERATION	20.00	72.00	R							148.31	59.49	21.84
			v							10.19	7.07	4.73
	21.00	75.60	R								65.25	23.93
			v								7.43	4.96
	22.00	79.20	R								71.27	26.12
			v								7.78	5.20
	23.00	82.80	R								77.54	28.39
			v								8.13	5.44
	24.00	86.40	R								84.08	30.75
			v								8.49	5.67
QUALITY MANAGEMENT	25.00	90.00	R								90.87	33.21
			v								8.84	5.91

# PLANNING AND DESIGN

## Pressure loss due to pipe resistance R and flow rate v depending on flow V

### Pipes SDR 7,4

Temperature 20 °C      Roughness: 0.007 mm      Density: 998.29 kg/m<sup>3</sup>      Kin. viscosity: 1.004E-06 m<sup>2</sup>/s

		Dimension	20 mm	25 mm	32 mm	40 mm	50 mm	63 mm	75 mm	90 mm	110 mm
		Wall thickness	2.8 mm	3.5 mm	4.4 mm	5.5 mm	6.9 mm	8.6 mm	10.3 mm	12.3 mm	15.1 mm
l/s	m <sup>3</sup> /h										
0.01	0.04	R in mbar/m v in m/s	0.10 0.06	0.04 0.04	0.01 0.02						
0.02	0.07	R v	0.30 0.12	0.11 0.08	0.03 0.05	0.01 0.03					
0.03	0.11	R v	0.58 0.18	0.21 0.12	0.06 0.07	0.02 0.05					
0.04	0.14	R v	0.93 0.25	0.33 0.16	0.10 0.09	0.04 0.06	0.01 0.04				
0.05	0.18	R v	1.34 0.31	0.47 0.20	0.15 0.12	0.05 0.08	0.02 0.05				
0.06	0.22	R v	1.82 0.37	0.64 0.24	0.20 0.14	0.07 0.09	0.03 0.06	0.01 0.04			
0.07	0.25	R v	2.36 0.43	0.83 0.28	0.25 0.17	0.09 0.11	0.03 0.07	0.01 0.04			
0.08	0.29	R v	2.96 0.49	1.04 0.31	0.32 0.19	0.11 0.12	0.04 0.08	0.01 0.05			
0.09	0.32	R v	3.61 0.55	1.26 0.35	0.38 0.21	0.14 0.14	0.05 0.09	0.02 0.05			
0.10	0.36	R v	4.32 0.61	1.51 0.39	0.46 0.24	0.16 0.15	0.06 0.10	0.02 0.06	0.01 0.04		
0.12	0.43	R v	5.90 0.74	2.05 0.47	0.62 0.28	0.22 0.18	0.08 0.12	0.03 0.07	0.01 0.05		
0.14	0.50	R v	7.70 0.86	2.67 0.55	0.81 0.33	0.28 0.21	0.10 0.14	0.03 0.08	0.02 0.06		
0.16	0.58	R v	9.70 0.98	3.36 0.63	1.01 0.38	0.35 0.24	0.13 0.16	0.04 0.10	0.02 0.07		
0.18	0.65	R v	11.91 1.11	4.11 0.71	1.24 0.43	0.43 0.27	0.15 0.17	0.05 0.11	0.02 0.08	0.01 0.05	
0.20	0.72	R v	14.32 1.23	4.94 0.79	1.48 0.47	0.52 0.30	0.18 0.19	0.06 0.12	0.03 0.09	0.01 0.06	
0.30	1.08	R v	29.30 1.84	10.01 1.18	2.98 0.71	1.03 0.45	0.36 0.29	0.12 0.18	0.05 0.13	0.02 0.09	0.01 0.06
0.40	1.44	R v	49.02 2.46	16.64 1.57	4.92 0.95	1.70 0.61	0.59 0.39	0.20 0.24	0.09 0.17	0.04 0.12	0.01 0.08
0.50	1.80	R v	73.35 3.07	24.77 1.96	7.29 1.18	2.50 0.76	0.87 0.49	0.29 0.30	0.13 0.22	0.05 0.15	0.02 0.10
0.60	2.16	R v	102.21 3.68	34.36 2.36	10.06 1.42	3.45 0.91	1.20 0.58	0.39 0.36	0.17 0.26	0.07 0.18	0.03 0.12
0.70	2.52	R v	135.57 4.30	45.40 2.75	13.24 1.66	4.52 1.06	1.57 0.68	0.51 0.42	0.23 0.30	0.09 0.21	0.04 0.14
0.80	2.88	R v	173.38 4.91	57.86 3.14	16.82 1.89	5.73 1.21	1.98 0.78	0.64 0.49	0.28 0.34	0.12 0.24	0.05 0.16
0.90	3.24	R v	215.63 5.53	71.73 3.54	20.78 2.13	7.06 1.36	2.43 0.87	0.79 0.55	0.35 0.39	0.15 0.27	0.06 0.18
1.00	3.60	R v	262.30 6.14	87.00 3.93	25.14 2.37	8.52 1.51	2.93 0.97	0.95 0.61	0.42 0.43	0.17 0.30	0.07 0.20
1.10	3.96	R v	313.36 6.75	103.67 4.32	29.87 2.60	10.11 1.67	3.47 1.07	1.12 0.67	0.49 0.47	0.21 0.33	0.08 0.22
1.20	4.32	R v	368.81 7.37	121.73 4.72	34.99 2.84	11.82 1.82	4.05 1.17	1.31 0.73	0.58 0.52	0.24 0.36	0.09 0.24
1.30	4.68	R v	428.65 7.98	141.17 5.11	40.48 3.08	13.65 1.97	4.67 1.26	1.51 0.79	0.66 0.56	0.28 0.39	0.11 0.26
1.40	5.04	R v	492.86 8.60	162.00 5.50	46.35 3.31	15.60 2.12	5.33 1.36	1.72 0.85	0.76 0.60	0.31 0.42	0.12 0.28
1.60	5.76	R v	634.39 9.82	207.77 6.29	59.21 3.78	19.86 2.42	6.77 1.55	2.18 0.97	0.96 0.69	0.40 0.48	0.15 0.32
1.80	6.48	R v	793.36 11.05	259.03 7.07	73.57 4.26	24.61 2.73	8.37 1.75	2.69 1.09	1.18 0.77	0.49 0.54	0.19 0.36
2.00	7.20	R v		315.77 7.86	89.40 4.73	29.83 3.03	10.12 1.94	3.24 1.21	1.42 0.86	0.59 0.60	0.23 0.40
2.20	7.92	R v		377.96 8.65	106.70 5.20	35.52 3.33	12.02 2.14	3.85 1.34	1.68 0.95	0.69 0.65	0.27 0.44
2.40	8.64	R v		445.60 9.43	125.47 5.68	41.67 3.63	14.08 2.33	4.50 1.46	1.96 1.03	0.81 0.71	0.31 0.48
2.60	9.36	R v		518.69 10.22	145.71 6.15	48.30 3.94	16.29 2.53	5.19 1.58	2.26 1.12	0.93 0.77	0.36 0.52

# PLANNING AND DESIGN

	Dimension	20 mm	25 mm	32 mm	40 mm	50 mm	63 mm	75 mm	90 mm	110 mm	SYSTEM DESCRIPTION		
											Wall thickness	2.8 mm	3.5 mm
2.80	10.08	R			167.40	55.38	18.64	5.93	2.58	1.06	0.41		
		v			6.62	4.24	2.72	1.70	1.20	0.83	0.56		
3.00	10.80	R			190.56	62.93	21.15	6.72	2.92	1.20	0.46		
		v			7.10	4.54	2.91	1.82	1.29	0.89	0.60		
3.50	12.60	R			254.82	83.82	28.07	8.89	3.86	1.58	0.61		
		v			8.28	5.30	3.40	2.12	1.51	1.04	0.70		
4.00	14.40	R			328.14	107.58	35.90	11.33	4.91	2.01	0.77		
		v			9.46	6.06	3.89	2.43	1.72	1.19	0.80		
4.50	16.20	R			410.53	134.19	44.65	14.06	6.07	2.49	0.95		
		v			10.65	6.81	4.37	2.73	1.94	1.34	0.90		
5.00	18.00	R			163.65	54.32	17.05	7.36	3.01	1.15	0.41		
		v			7.57	4.86	3.03	2.15	1.49	1.00	0.70		
5.50	19.80	R			195.95	64.88	20.32	8.75	3.57	1.36	0.46		
		v			8.33	5.34	3.34	2.37	1.64	1.10	0.70		
6.00	21.60	R			231.09	76.36	23.86	10.26	4.18	1.60	0.56		
		v			9.08	5.83	3.64	2.58	1.79	1.20	0.46		
6.50	23.40	R			269.06	88.73	27.68	11.89	4.84	1.84	0.61		
		v			9.84	6.32	3.95	2.80	1.93	1.30	0.46		
7.00	25.20	R			309.86	102.00	31.76	13.62	5.54	2.11	0.77		
		v			10.60	6.80	4.25	3.01	2.08	1.40	0.90		
7.50	27.00	R			116.17	116.17	36.10	15.47	6.28	2.39	0.83		
		v			7.29	4.55	3.23	2.23	1.50	1.00	0.70		
8.00	28.80	R			131.24	131.24	40.72	17.42	7.07	2.68	0.95		
		v			7.77	4.86	3.44	2.38	1.60	1.10	0.70		
8.50	30.60	R			147.20	147.20	45.60	19.49	7.90	3.00	1.06		
		v			8.26	5.16	3.66	2.53	1.70	1.20	0.46		
9.00	32.40	R			164.05	164.05	50.75	21.67	8.77	3.32	1.15		
		v			8.74	5.46	3.87	2.68	1.80	1.30	0.46		
9.50	34.20	R			181.80	181.80	56.16	23.96	9.69	3.67	1.26		
		v			9.23	5.77	4.09	2.83	1.90	1.40	0.90		
10.00	36.00	R			200.45	200.45	61.84	26.35	10.65	4.03	1.46		
		v			9.72	6.07	4.30	2.98	2.00	1.40	0.90		
10.50	37.80	R			219.98	219.98	67.78	28.86	11.65	4.40	1.56		
		v			10.20	6.37	4.52	3.13	2.10	1.40	0.90		
11.00	39.60	R			73.99	73.99	31.48	12.70	4.79	1.70	0.61		
		v			6.68	4.73	3.27	2.20	1.50	1.00	0.70		
11.50	41.40	R			80.46	80.46	34.20	13.78	5.20	1.80	0.61		
		v			6.98	4.95	3.42	2.30	1.60	1.10	0.70		
12.00	43.20	R			87.20	87.20	37.04	14.91	5.62	2.00	0.70		
		v			7.28	5.16	3.57	2.40	1.70	1.20	0.46		
12.50	45.00	R			94.20	94.20	39.98	16.09	6.06	2.20	0.80		
		v			7.59	5.38	3.72	2.50	1.80	1.30	0.46		
13.00	46.80	R			101.46	101.46	43.03	17.30	6.51	2.30	0.80		
		v			7.89	5.59	3.87	2.60	2.00	1.40	0.90		
13.50	48.60	R			108.99	108.99	46.19	18.56	6.98	2.40	0.80		
		v			8.19	5.81	4.02	2.70	2.10	1.50	1.00		
14.00	50.40	R			116.78	116.78	49.46	19.86	7.46	2.60	0.90		
		v			8.50	6.02	4.17	2.80	2.30	1.60	1.10		
14.50	52.20	R			124.83	124.83	52.84	21.20	7.96	2.70	0.90		
		v			8.80	6.24	4.32	2.90	2.40	1.70	1.20		
15.00	54.00	R			133.14	133.14	56.33	22.59	8.48	2.80	1.00		
		v			9.10	6.45	4.47	3.00	2.50	1.70	1.20		
16.00	57.60	R			150.56	150.56	63.62	25.48	9.55	3.20	1.10		
		v			9.71	6.88	4.76	3.20	2.80	1.90	1.40		
17.00	61.20	R			169.03	169.03	71.35	28.54	10.69	3.40	1.20		
		v			10.32	7.31	5.06	3.40	3.00	2.00	1.40		
18.00	64.80	R			79.51	79.51	31.77	11.88	4.10	1.40	0.50		
		v			7.74	5.36	3.60	2.60	2.20	1.60	1.10		
19.00	68.40	R			88.09	88.09	35.16	13.14	4.50	1.60	0.50		
		v			8.17	5.66	3.80	2.70	2.30	1.70	1.20		
20.00	72.00	R			97.11	97.11	38.73	14.45	4.90	1.70	0.60		
		v			8.60	5.95	4.00	2.80	2.40	1.80	1.30		
21.00	75.60	R			106.56	106.56	42.46	15.83	5.20	1.80	0.60		
		v			9.04	6.25	4.20	2.90	2.50	1.90	1.40		
22.00	79.20	R			116.44	116.44	46.35	17.26	5.60	2.00	0.70		
		v			9.47	6.55	4.40	3.00	2.60	2.00	1.40		
23.00	82.80	R			126.75	126.75	50.41	18.76	6.00	2.10	0.70		
		v			9.90	6.85	4.60	3.10	2.70	2.10	1.50		
24.00	86.40	R			137.49	137.49	54.64	20.31	6.40	2.20	0.80		
		v			10.33	7.14	4.80	3.20	2.80	2.20	1.60		
25.00	90.00	R			149.03	149.03	59.03	21.93	6.80	2.30	0.80		
		v			10.77	7.44	5.00	3.30	2.90	2.30	1.70		
26.00	93.60	R			161.59	161.59	63.59	23.60	7.20	2.40	0.90		
		v			11.21	7.74	5.20	3.40	3.00	2.40	1.80		



# PLANNING AND DESIGN

		Dimension	20 mm	25 mm	32 mm	40 mm	50 mm	63 mm	75 mm	90 mm	110 mm
		Wall thickness	2.8 mm	3.5 mm	4.4 mm	5.5 mm	6.9 mm	8.6 mm	10.3 mm	12.3 mm	15.1 mm
l/s	m³/h										
27.00	97.20	R								68.31	25.34
		v								8.04	5.40
28.00	100.80	R								73.20	27.13
		v								8.34	5.60
29.00	104.40	R								78.26	28.98
		v								8.63	5.80
30.00	108.00	R								83.48	30.90
		v								8.93	6.00
32.00	115.20	R								94.42	34.90
		v								9.53	6.40
34.00	122.40	R								106.01	39.14
		v								10.12	6.80
36.00	129.60	R									43.61
		v									7.20
38.00	136.80	R									48.32
		v									7.60
40.00	144.00	R									53.27
		v									8.00
42.00	151.20	R									58.45
		v									8.40
44.00	158.40	R									63.87
		v									8.80
46.00	165.60	R									69.53
		v									9.20
48.00	172.80	R									75.42
		v									9.60
50.00	180.00	R									81.54
		v									10.00
52.00	187.20	R									
		v									
54.00	194.40	R									
		v									
56.00	201.60	R									
		v									
58.00	208.80	R									
		v									
60.00	216.00	R									
		v									
62.00	223.20	R									
		v									
64.00	230.40	R									
		v									
66.00	237.60	R									
		v									
68.00	244.80	R									
		v									
70.00	252.00	R									
		v									
72.00	259.20	R									
		v									
74.00	266.40	R									
		v									
78.00	280.80	R									
		v									
80.00	288.00	R									
		v									
82.00	295.20	R									
		v									
84.00	302.40	R									
		v									
86.00	309.60	R									
		v									
88.00	316.80	R									
		v									
90.00	324.00	R									
		v									

SYSTEM DESCRIPTION
TRANSPORTATION AND STORAGE
DRINKING WATER HYGIENE
SYSTEM REQUIREMENTS
PLANNING AND DESIGN
WELDING TECHNOLOGY
ASSEMBLY GUIDELINES
INITIAL OPERATION
QUALITY MANAGEMENT

# PLANNING AND DESIGN

## Pressure loss due to pipe resistance R and flow rate v depending on flow V

### Pipes SDR 11

Temperatur 20 °C      Roughness: 0.007 mm      Density: 998.29 kg/m<sup>3</sup>      Kin. viscosity: 1.004E-06 m<sup>2</sup>/s

SYSTEM DESCRIPTION	TRANSPORTATION AND STORAGE	DRINKING WATER HYGIENE	SYSTEM REQUIREMENTS	PLANNING AND DESIGN	WELDING TECHNOLOGY	ASSEMBLY GUIDELINES	INITIAL OPERATION	QUALITY MANAGEMENT	Dimension	20 mm	25 mm	32 mm	40 mm	50 mm	63 mm	75 mm	90 mm	110 mm	
									Wall thickness	1.9 mm	2.3 mm	2.9 mm	3.7 mm	4.6 mm	5.8 mm	6.8 mm	8.2 mm	10.0 mm	
	l/s	m <sup>3</sup> /h							R in mbar/m										
	0.01	0.04							v in m/s	0.06	0.02	0.01							
	0.02	0.07							R	0.18	0.06	0.02	0.01						
									v	0.10	0.06	0.04	0.02						
	0.03	0.11							R	0.34	0.12	0.04	0.01						
									v	0.15	0.09	0.06	0.04						
	0.04	0.14							R	0.54	0.18	0.06	0.02	0.01					
									v	0.19	0.12	0.07	0.05	0.03					
	0.05	0.18							R	0.78	0.27	0.08	0.03	0.01					
									v	0.24	0.15	0.09	0.06	0.04					
	0.06	0.22							R	1.05	0.36	0.11	0.04	0.01	0.01				
									v	0.29	0.18	0.11	0.07	0.05	0.03				
	0.07	0.25							R	1.36	0.46	0.14	0.05	0.02	0.01				
									v	0.34	0.21	0.13	0.08	0.05	0.03				
	0.08	0.29							R	1.70	0.58	0.18	0.06	0.02	0.01				
									v	0.39	0.24	0.15	0.10	0.06	0.04				
	0.09	0.32							R	2.07	0.70	0.22	0.08	0.03	0.01				
									v	0.44	0.28	0.17	0.11	0.07	0.04				
	0.10	0.36							R	2.48	0.84	0.26	0.09	0.03	0.01	0.01			
									v	0.49	0.31	0.19	0.12	0.08	0.05	0.03			
	0.12	0.43							R	3.38	1.14	0.35	0.13	0.04	0.02	0.01			
									v	0.58	0.37	0.22	0.14	0.09	0.06	0.04			
	0.14	0.50							R	4.40	1.48	0.46	0.16	0.06	0.02	0.01			
									v	0.68	0.43	0.26	0.17	0.11	0.07	0.05			
	0.16	0.58							R	5.54	1.86	0.57	0.20	0.07	0.02	0.01			
									v	0.78	0.49	0.30	0.19	0.12	0.08	0.05			
	0.18	0.65							R	6.79	2.27	0.70	0.25	0.09	0.03	0.01	0.01		
									v	0.87	0.55	0.33	0.22	0.14	0.09	0.06	0.04		
	0.20	0.72							R	8.16	2.72	0.83	0.30	0.10	0.04	0.02	0.01		
									v	0.97	0.61	0.37	0.24	0.15	0.10	0.07	0.05		
	0.30	1.08							R	16.61	5.50	1.67	0.59	0.21	0.07	0.03	0.01	0.01	
									v	1.46	0.92	0.56	0.36	0.23	0.14	0.10	0.07	0.05	0.05
	0.40	1.44							R	27.68	9.11	2.75	0.97	0.34	0.11	0.05	0.02	0.01	
									v	1.94	1.22	0.74	0.48	0.31	0.19	0.14	0.09	0.09	0.06
	0.50	1.80							R	41.30	13.53	4.07	1.43	0.49	0.17	0.07	0.03	0.01	
									v	2.43	1.53	0.93	0.60	0.38	0.24	0.17	0.12	0.08	0.01
	0.60	2.16							R	57.42	18.73	5.61	1.97	0.68	0.23	0.10	0.04	0.02	
									v	2.91	1.84	1.11	0.72	0.46	0.29	0.20	0.14	0.09	0.02
	0.70	2.52							R	75.99	24.69	7.37	2.58	0.89	0.30	0.13	0.05	0.02	
									v	3.40	2.14	1.30	0.84	0.54	0.34	0.24	0.16	0.11	0.03
	0.80	2.88							R	97.01	31.41	9.34	3.27	1.12	0.37	0.16	0.07	0.03	
									v	3.88	2.45	1.48	0.96	0.61	0.39	0.27	0.19	0.13	0.03
	0.90	3.24							R	120.44	38.87	11.53	4.02	1.37	0.46	0.20	0.08	0.03	
									v	4.37	2.75	1.67	1.08	0.69	0.43	0.30	0.21	0.14	0.03
	1.00	3.60							R	146.28	47.08	13.93	4.85	1.65	0.55	0.24	0.10	0.04	
									v	4.85	3.06	1.85	1.20	0.76	0.48	0.34	0.24	0.16	0.04
	1.10	3.96							R	174.52	56.03	16.53	5.74	1.96	0.65	0.28	0.12	0.05	
									v	5.34	3.37	2.04	1.32	0.84	0.53	0.37	0.26	0.17	0.05
	1.20	4.32							R	205.14	65.70	19.34	6.71	2.28	0.76	0.32	0.14	0.05	
									v	5.82	3.67	2.23	1.44	0.92	0.58	0.41	0.28	0.19	0.05
	1.30	4.68							R	238.15	76.11	22.36	7.74	2.63	0.87	0.37	0.16	0.06	
									v	6.31	3.98	2.41	1.56	0.99	0.63	0.44	0.31	0.20	0.06
	1.40	5.04							R	273.54	87.24	25.57	8.84	3.00	0.99	0.42	0.18	0.07	
									v	6.79	4.28	2.60	1.68	1.07	0.67	0.47	0.33	0.22	0.07
	1.60	5.76							R	351.43	111.67	32.61	11.25	3.80	1.25	0.54	0.23	0.09	
									v	7.76	4.90	2.97	1.92	1.22	0.77	0.54	0.38	0.25	0.09
	1.80	6.48							R	438.78	138.97	40.45	13.91	4.69	1.54	0.66	0.28	0.11	
									v	8.73	5.51	3.34	2.16	1.38	0.87	0.61	0.42	0.28	0.11
	2.00	7.20							R	535.58	169.14	49.09	16.84	5.67	1.86	0.79	0.33	0.13	
									v	9.70	6.12	3.71	2.40	1.53	0.96	0.68	0.47	0.31	0.13
	2.20	7.92							R	641.81	202.17	58.51	20.03	6.73	2.21	0.94	0.39	0.15	
									v	10.67	6.73	4.08	2.64	1.68	1.06	0.74	0.52	0.35	0.15
	2.40	8.64							R	734.06	238.06	68.72	23.48	7.87	2.58	1.10	0.46	0.18	
									v	12.61	7.34	4.45	2.88	1.84	1.16	0.81	0.56	0.38	0.18
	2.60	9.36							R	841.81	276.78	79.71	27.18	9.10	2.97	1.26	0.53	0.20	
									v	14.14	7.95	4.82	3.11	1.99	1.25	0.88	0.61	0.41	0.20

# PLANNING AND DESIGN

	Dimension	20 mm	25 mm	32 mm	40 mm	50 mm	63 mm	75 mm	90 mm	110 mm	SYSTEM DESCRIPTION	
											Wall thickness	1.9 mm
l/s	m <sup>3</sup> /h											TRANSPORTATION AND STORAGE
2.80	10.08	R		318.35	91.49	31.14	10.40	3.40	1.44	0.60	0.23	SYSTEM DESCRIPTION
		v		8.57	5.19	3.35	2.14	1.35	0.95	0.66	0.44	
3.00	10.80	R		362.76	104.04	35.35	11.79	3.84	1.63	0.68	0.26	TRANSPORTATION AND STORAGE
		v		9.18	5.56	3.59	2.29	1.45	1.01	0.71	0.47	
3.50	12.60	R		486.16	138.82	47.00	15.62	5.07	2.15	0.90	0.34	DRINKING WATER HYGIENE
		v		10.71	6.49	4.19	2.68	1.69	1.18	0.82	0.55	
4.00	14.40	R			178.44	60.21	19.95	6.46	2.73	1.14	0.43	DRINKING WATER HYGIENE
		v			7.42	4.79	3.06	1.93	1.35	0.94	0.63	
4.50	16.20	R			222.89	74.99	24.77	8.01	3.38	1.41	0.53	DRINKING WATER HYGIENE
		v			8.35	5.39	3.44	2.17	1.52	1.06	0.71	
5.00	18.00	R			272.15	91.32	30.09	9.70	4.08	1.70	0.64	DRINKING WATER HYGIENE
		v			9.27	5.99	3.82	2.41	1.69	1.18	0.79	
5.50	19.80	R			326.21	109.21	35.90	11.55	4.85	2.02	0.76	DRINKING WATER HYGIENE
		v			10.20	6.59	4.21	2.65	1.86	1.29	0.86	
6.00	21.60	R				128.65	42.20	13.55	5.69	2.36	0.89	DRINKING WATER HYGIENE
		v				7.19	4.59	2.89	2.03	1.41	0.94	
6.50	23.40	R				149.64	48.99	15.70	6.58	2.73	1.03	DRINKING WATER HYGIENE
		v				7.79	4.97	3.13	2.20	1.53	1.02	
7.00	25.20	R				172.17	56.26	17.99	7.53	3.12	1.18	DRINKING WATER HYGIENE
		v				8.39	5.35	3.37	2.36	1.65	1.10	
7.50	27.00	R				196.24	64.02	20.44	8.55	3.53	1.33	DRINKING WATER HYGIENE
		v				8.99	5.74	3.61	2.53	1.76	1.18	
8.00	28.80	R				221.85	72.27	23.03	9.62	3.97	1.50	SYSTEM REQUIREMENTS
		v				9.58	6.12	3.86	2.70	1.88	1.26	
8.50	30.60	R				249.01	80.99	25.78	10.76	4.44	1.67	SYSTEM REQUIREMENTS
		v				10.18	6.50	4.10	2.87	2.00	1.34	
9.00	32.40	R					90.20	28.67	11.95	4.93	1.85	SYSTEM REQUIREMENTS
		v					6.88	4.34	3.04	2.12	1.41	
9.50	34.20	R					99.89	31.70	13.20	5.44	2.04	SYSTEM REQUIREMENTS
		v					7.27	4.58	3.21	2.23	1.49	
10.00	36.00	R					110.06	34.89	14.52	5.97	2.24	SYSTEM REQUIREMENTS
		v					7.65	4.82	3.38	2.35	1.57	
10.50	37.80	R					120.71	38.22	15.89	6.53	2.45	PLANNING AND DESIGN
		v					8.03	5.06	3.55	2.47	1.65	
11.00	39.60	R					131.84	41.69	17.32	7.12	2.67	PLANNING AND DESIGN
		v					8.41	5.30	3.72	2.59	1.73	
11.50	41.40	R					143.45	45.32	18.81	7.72	2.89	PLANNING AND DESIGN
		v					8.80	5.54	3.88	2.70	1.81	
12.00	43.20	R					155.54	49.08	20.36	8.35	3.13	PLANNING AND DESIGN
		v					9.18	5.78	4.05	2.82	1.89	
12.50	45.00	R					168.11	53.00	21.96	9.00	3.37	PLANNING AND DESIGN
		v					9.56	6.02	4.22	2.94	1.96	
13.00	46.80	R					181.16	57.06	23.63	9.68	3.62	WELDING TECHNOLOGY
		v					9.94	6.27	4.39	3.06	2.04	
13.50	48.60	R					194.69	61.26	25.35	10.38	3.88	WELDING TECHNOLOGY
		v					10.33	6.51	4.56	3.17	2.12	
14.00	50.40	R						65.61	27.13	11.10	4.14	WELDING TECHNOLOGY
		v						6.75	4.73	3.29	2.20	
14.50	52.20	R						70.10	28.97	11.84	4.42	WELDING TECHNOLOGY
		v						6.99	4.90	3.41	2.28	
15.00	54.00	R						74.74	30.87	12.61	4.70	WELDING TECHNOLOGY
		v						7.23	5.07	3.53	2.36	
16.00	57.60	R						84.46	34.84	14.22	5.30	ASSEMBLY GUIDELINES
		v						7.71	5.40	3.76	2.52	
17.00	61.20	R						94.75	39.04	15.91	5.92	ASSEMBLY GUIDELINES
		v						8.19	5.74	4.00	2.67	
18.00	64.80	R						105.62	43.47	17.70	6.58	ASSEMBLY GUIDELINES
		v						8.67	6.08	4.23	2.83	
19.00	68.40	R						117.06	48.13	19.58	7.27	ASSEMBLY GUIDELINES
		v						9.16	6.42	4.47	2.99	
20.00	72.00	R						129.09	53.03	21.55	7.99	ASSEMBLY GUIDELINES
		v						9.64	6.75	4.70	3.14	
21.00	75.60	R						141.69	58.15	23.61	8.75	INITIAL OPERATION
		v						10.12	7.09	4.94	3.30	
22.00	79.20	R							63.51	25.77	9.54	INITIAL OPERATION
		v							7.43	5.17	3.46	
23.00	82.80	R							69.09	28.01	10.36	INITIAL OPERATION
		v							7.77	5.41	3.62	
24.00	86.40	R							74.90	30.34	11.21	INITIAL OPERATION
		v							8.11	5.64	3.77	
25.00	90.00	R							80.95	32.76	12.10	INITIAL OPERATION
		v							8.44	5.88	3.93	
26.00	93.60	R							87.22	35.28	13.02	QUALITY MANAGEMENT
		v							8.78	6.11	4.09	

# PLANNING AND DESIGN

SYSTEM DESCRIPTION	Dimension		20 mm	25 mm	32 mm	40 mm	50 mm	63 mm	75 mm	90 mm	110 mm
	l/s	m³/h	Wall thickness 1.9 mm	2.3 mm	2.9 mm	3.7 mm	4.6 mm	5.8 mm	6.8 mm	8.2 mm	10.0 mm
SYSTEM DESCRIPTION	27.00	97.20	R						93.72	37.88	13.97
			v						9.12	6.35	4.24
SYSTEM DESCRIPTION	28.00	100.80	R						100.46	40.57	14.95
			v						9.46	6.58	4.40
SYSTEM DESCRIPTION	29.00	104.40	R						107.42	43.36	15.96
			v						9.79	6.82	4.56
SYSTEM DESCRIPTION	30.00	108.00	R						114.61	46.23	17.01
			v						10.13	7.05	4.72
SYSTEM DESCRIPTION	32.00	115.20	R							52.25	19.20
			v							7.52	5.03
SYSTEM DESCRIPTION	34.00	122.40	R							58.62	21.51
			v							7.99	5.34
SYSTEM DESCRIPTION	36.00	129.60	R							65.36	23.96
			v							8.46	5.66
SYSTEM DESCRIPTION	38.00	136.80	R							72.45	26.53
			v							8.93	5.97
SYSTEM DESCRIPTION	40.00	144.00	R							79.90	29.22
			v							9.40	6.29
SYSTEM DESCRIPTION	42.00	151.20	R							87.71	32.05
			v							9.87	6.60
SYSTEM DESCRIPTION	44.00	158.40	R							95.87	35.00
			v							10.34	6.92
SYSTEM DESCRIPTION	46.00	165.60	R								38.08
			v								
SYSTEM DESCRIPTION	48.00	172.80	R								41.28
			v								
SYSTEM DESCRIPTION	50.00	180.00	R								44.61
			v								
SYSTEM DESCRIPTION	52.00	187.20	R								48.07
			v								
SYSTEM DESCRIPTION	54.00	194.40	R								51.65
			v								
SYSTEM DESCRIPTION	56.00	201.60	R								55.36
			v								
SYSTEM DESCRIPTION	58.00	208.80	R								59.20
			v								
SYSTEM DESCRIPTION	60.00	216.00	R								63.16
			v								
SYSTEM DESCRIPTION	62.00	223.20	R								67.24
			v								
SYSTEM DESCRIPTION	64.00	230.40	R								71.46
			v								
SYSTEM DESCRIPTION	66.00	237.60	R								
			v								
SYSTEM DESCRIPTION	68.00	244.80	R								
			v								
SYSTEM DESCRIPTION	70.00	252.00	R								
			v								
SYSTEM DESCRIPTION	75.00	270.00	R								
			v								
SYSTEM DESCRIPTION	80.00	288.00	R								
			v								
SYSTEM DESCRIPTION	85.00	306.00	R								
			v								
SYSTEM DESCRIPTION	90.00	324.00	R								
			v								
SYSTEM DESCRIPTION	95.00	342.00	R								
			v								
SYSTEM DESCRIPTION	100.00	360.00	R								
			v								
SYSTEM DESCRIPTION	110.00	396.00	R								
			v								
SYSTEM DESCRIPTION	120.00	432.00	R								
			v								
SYSTEM DESCRIPTION	130.00	468.00	R								
			v								
SYSTEM DESCRIPTION	140.00	504.00	R								
			v								
SYSTEM DESCRIPTION	150.00	540.00	R								
			v								
SYSTEM DESCRIPTION	160.00	576.00	R								
			v								
SYSTEM DESCRIPTION	170.00	612.00	R								
			v								

# PLANNING AND DESIGN

## 5.2 Simplified procedure

### General information

This section describes a simple method suitable to determine the inner pipe diameters for standard installations. The procedure can be applied to all building types, which do not have above-average dimensions. This means that the simplified procedure is suitable for the vast majority of all buildings.

The method is applied in the same way for both cold and hot water pipes.

### Differentiating calculation procedure

The planner is free to determine the inner pipe diameters through the use of nationally recognised differentiating methods of calculation.

### Hot water circulation pipes

Hot water circulation pipes are subject to other hydraulic laws and cannot be measured with this method.

Flow velocities in hot water circulation pipes must be determined in accordance with national recommendations or manufacturer guidelines

### Load unit

1 load unit (LU) is equal to a tapping point fitting flow rate  $Q_A$  of 0.1 l/s.

### Tapping point fitting flow rates $Q_A$ , minimum draw-off point fitting flow rates $Q_{min}$ and load units for tapping points

Table 12

Tapping point	$Q_A$	$Q_{min}$	Load unit
	l/s	l/s	
wash basin, hand basin, bidet, cistern	0.1	0.1	1
household kitchen sink, household washing machine*, dishwasher, utility sink, shower head	0.2	0.15	2
urinal flusher	0.3	0.15	3
bath tub outlet	0.4	0.3	4
garden/garage tap	0.5	0.4	5
commercial kitchen sink DN 20, commercial bath tub outlet	0.8	0.8	8
flusher DN 20	1.5	1.0	15

\* for commercial washing machines refer to the manufacturer's recommendations

The values listed above do not correspond to the values provided in product standards. They are merely used for the determination of inner pipe diameters.

### Application of the simplified procedure

Starting from the farthest tapping point, the load units for the installation's individual pipe sections must be determined. The load units are then added. The probability of simultaneous use and of peak flow QD has been taken into account in the table of load values. Therefore, the inner pipe diameter can be obtained from the table.

The simplified calculation procedure is based on following flow rates.

Collecting lines, risers, floor level lines	maximum 2.0 m/s
Single supply lines	maximum 4.0 m/s

Note: National regulations may require lower flow rates, in order to prevent pressure surges and noise.

# PLANNING AND DESIGN

Load units LU for the determination of the inner pipe diameters

Table 13

		PP pipe SDR 6											
maximum load value	LU	1	2	3	3	4	6	13	30	70	200	540	970
greatest single value	LU			2			4	5	8				
$d_a \times s$	mm	16 × 2.7		20 × 3.4		25 × 4.2		32 × 5.4		40 × 6.7		50 × 8.4	
$d_i$	mm	10.6		13.2		16.6		21.2		26.6		33.2	
maximum pipe length	m	20	12	8	15	9	7						

Example: Determining the inner pipe diameter for standard installations

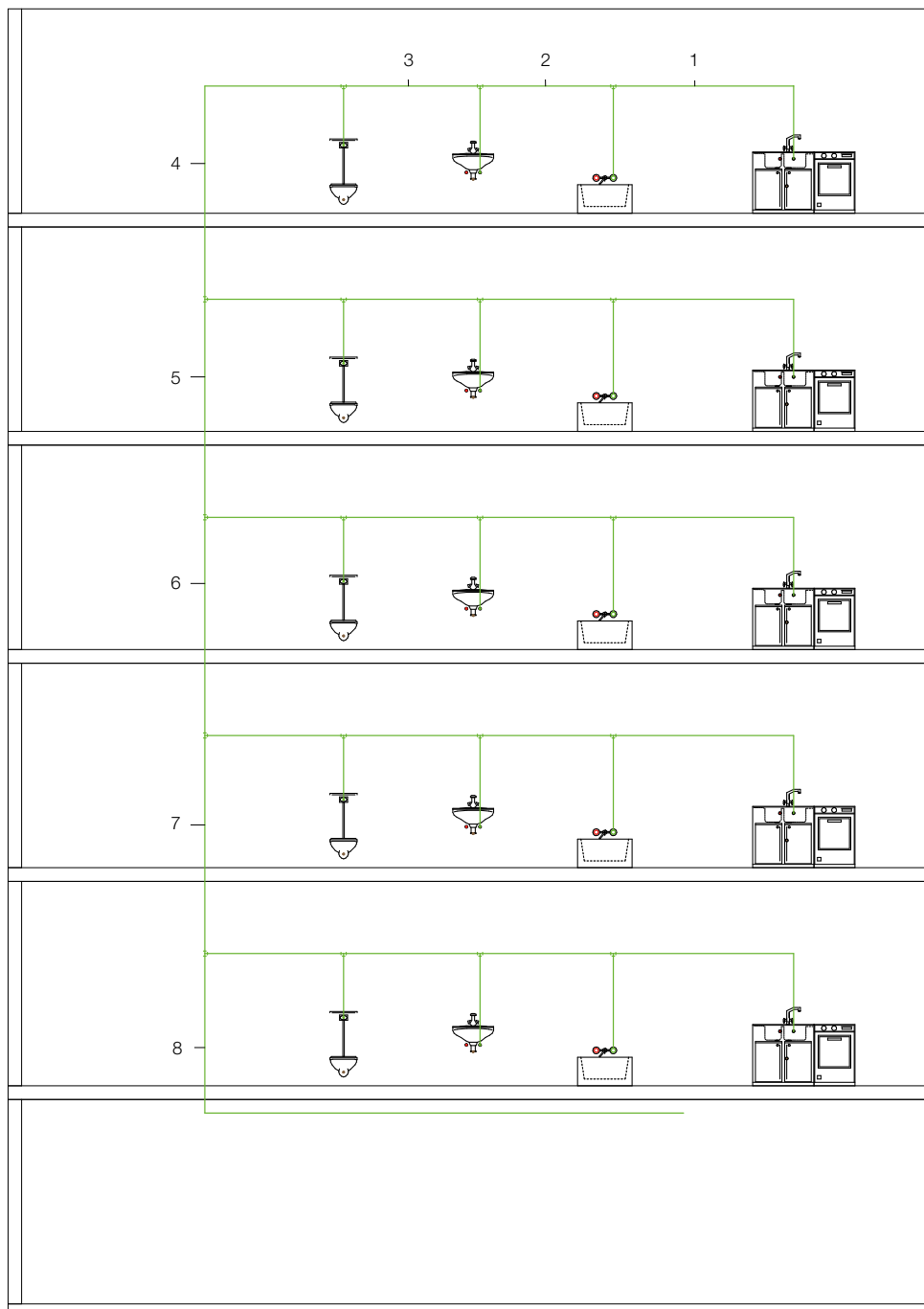

# PLANNING AND DESIGN

## Implementation

Starting from the farthest tapping point, the load units for the individual pipe sections must be added. Then, the inner pipe diameters are determined.

## Definition of tasks in accordance with the installation plan

Calculate the cold water pipe leading from the basement to the tapping points. Calculate the pipeline as required for plastic pipes made of PP.

## The following tapping points are installed in every apartment:

- 1 bath tub
  - 1 WC with cistern
  - 1 wash basin
  - 1 household kitchen sink
- There are five similar apartments in total.

## Solution

The load units are to be determined according to

Table 13:

1 bath tub	4 LU
1 WC with cistern	1 LU
1 wash basin	1 LU
1 household kitchen sink	2 LU

## Section 1

1 kitchen sink connected = 2 LU

Table 13 shows 2 LU = pipe 16 mm,  
maximum length 8 m

## Section 2

1 kitchen sink connected = 2 LU

1 bath connected = 4 LU

Total = 6 LU

Table 13 shows 6 LU = pipe 20 mm,  
maximum length 7 m

## Section 3

1 kitchen sink connected = 2 LU

1 bath connected = 4 LU

1 wash basin connected = 1 LU

Total = 7 LU

Table 13 shows 7 LU = pipe 25 mm

## Section 4

1 kitchen sink = 2 LU

1 bath = 4 LU

1 wash basin = 1 LU

1 cistern = 1 LU

Total for 1 apartment = 8 LU

Table 13 shows 8 LU = pipe 25 mm

## Section 5

2 apartments connected = 16 LU

Table 13 shows 16 LU = pipe 32 mm

## Section 6

3 apartments connected = 24 LU

Table 13 shows 24 LU = pipe 32 mm

## Section 7

4 apartments connected = 32 LU

Table 13 shows 32 LU = pipe 40 mm

## Section 8

5 apartments connected = 40 LU

Table 13 shows 40 LU = pipe 40 mm

SYSTEM  
DESCRIPTION

TRANSPORTATION  
AND STORAGE

DRINKING WATER  
HYGIENE

SYSTEM  
REQUIREMENTS

PLANNING AND  
DESIGN

WELDING  
TECHNOLOGY

ASSEMBLY  
GUIDELINES

INITIAL  
OPERATION

QUALITY  
MANAGEMENT

# WELDING TECHNOLOGY

## 6.1 Basic information

### 6.1.1 Socket welding using a heated tool

Before starting the work, make sure that the welding tools lie flat against the heated rod. Do not use pliers or other unsuitable tools for the assembly, to avoid damage to the coating of the welding tools.

The required welding temperature for processing the POLYMUTAN installation system is 250 to 270 °C.

**Warning:**

- Danger of burns from hot welding equipment
- The first welding should not be carried out until five minutes after the welding temperature has been reached!

POLYMUTAN welding equipment and welding tools must be protected against impurities. Burned-on particles can lead to faulty welding connections. Tools may be cleaned with non-fibrous, coarse paper towels. The welding tools must be kept dry at all times.

Damaged and soiled welding tools must be replaced, since only impeccable processing tools can ensure impeccable connections.

Connect the components during the welding process without twisting the parts. Minor corrections can only be made immediately after the parts are connected.

### 6.1.2 Guidelines

General work protection and accident prevention guidelines are to be observed when using welding equipment.

The Guidelines of the Industrial Trade Associations of the Chemical Industry for Machines for the Processing and Employment of Plastics, Chapter: Welding Machines and Equipment, apply.

For the handling of POLYMUTAN welding equipment, machines and tools, the General Guidelines DVS 2208, Section 1 apply. In order to establish a connection between the POLYMUTAN pipe and the fitted part, the welding tools used must correspond to the measurements as stipulated by procedure A.

In accordance with DVS Guidelines, control of the necessary application temperature using quick-display surface temperature thermometers is permissible.

SYSTEM  
DESCRIPTION

TRANSPORTATION  
AND STORAGE

DRINKING WATER  
HYGIENE

SYSTEM  
REQUIREMENTS

PLANNING AND  
DESIGN

WELDING  
TECHNOLOGY

ASSEMBLY  
GUIDELINES

INITIAL  
OPERATION

QUALITY  
MANAGEMENT



## 6.2 Processing information for welding

Parameters for socket welding with a heated tool

Table 14

Outer pipe diameter mm	Insertion depth mm	Heating period for SDR 11, SDR 7.4, SDR 6 at 20°	Processing period (maximum period) s	Cooling period	
				fixed s	total min
20	14	5	4	6	2
25	15	7	4	10	2
32	16.5	8	6	10	4
40	18	12	6	20	4
50	20	18	6	20	4
63	24	24	8	30	6
75	26	30	8	30	6
90	29	40	8	40	6
110	32.5	50	10	50	8

Note: heating element temperature 250 to 270 °C

Instructions for socket welding can be found in DVS brochure no. 2207, Section 11, "Socket welding with a heated tool – welding of thermoplastic plastics and pipelines made of polypropylene (PP)". POLYMUTAN socket welding is performed according to these guidelines.

In this process, pipes and fittings are welded overlapping. The end of the pipes and fittings are heated using a welding device and are subsequently connected.

SYSTEM  
DESCRIPTION

TRANSPORTATION  
AND STORAGE

DRINKING WATER  
HYGIENE

SYSTEM  
REQUIREMENTS

PLANNING AND  
DESIGN

WELDING  
TECHNOLOGY

ASSEMBLY  
GUIDELINES

INITIAL  
OPERATION

QUALITY  
MANAGEMENT

# WELDING TECHNOLOGY

## 6.2.1 Socket welding with a hand-held welding device, from 20 mm

The following points should be observed:

1. The welding device should be equipped with the appropriate welding tools. Welding bushes and core rods have a Teflon coating. In order to avoid damaging the Teflon coating, never use pliers or similar tools for assembly. Please use a suitable hexagon socket wrench.
2. Switch on the welding device.
3. Using a thermometer or a temperature control pin, check welding temperature before starting to weld.
4. The ends of the pipes must be cut straight. Use appropriate pipe scissors or cutters. Pipe, fittings and welding tools must be clean. If necessary, clean them with a lint-free cloth.
5. Fitting and pipe must be inserted quickly and axially, without twisting, into the corresponding welding tools. The parts to be welded are then heated without pressure according to the table.
6. After the required heating time, fitting and pipe are to be removed quickly from the heating element and connected immediately by pushing together without twisting until insertion depth or markings have been reached. A double roll provides a visual guide to determine the correct welding (see DVS brochure 2207, Section 11). The line markings on the fittings and the pipe ensure the proper alignment of the pipes.
7. Pressure due to subsequent installation works must not be exerted upon the welded connection until after the end of the cooling period.
8. If necessary, clean the welding tools after each use.



SYSTEM  
DESCRIPTION

TRANSPORTATION  
AND STORAGE

DRINKING WATER  
HYGIENE

SYSTEM  
REQUIREMENTS

PLANNING AND  
DESIGN

WELDING  
TECHNOLOGY

ASSEMBLY  
GUIDELINES

INITIAL  
OPERATION

QUALITY  
MANAGEMENT

# WELDING TECHNOLOGY

## 6.2.2 Socket welding with a stationary welding machine, from 40 mm

### 6.2.2.1 Area of use

We recommend the use of a stationary welding machine for the welding of larger pipe diameters and for the pre-assembly of installation elements. The general guidelines provided by DVS brochure no. 2207, Section 11, "Socket welding with a heated tool. Detailed information on welding times." apply here.

### 6.2.2.2 Processing steps

1. Check the machine: Establish welding insertion depth by setting the dimension; make sure the welding temperature is reached.
2. Fix the moulded part with the clamp, taking care not to wind it too tightly, as this can lead to ovality, with a negative impact on the resulting weld. Make sure the moulded part is correctly positioned; use counter-tension to prevent the possibility of slipping.
3. Place the pipe loosely into the jaw chuck.
4. Adjust the dimension using the rotary button, which sets the precise welding insertion depth.
5. Push both tools together until they reach the stop.
6. Push the pipe as far as the fitting, then tighten. Make sure that the welding partners are accurately aligned. Open the welding tool.
7. Insert the welding device. Using the crank, gradually push the fitting and the pipe into the tool until the stop is reached. Pay attention to the welding time.
8. The welding period begins when the pipe and the fitting have been fitted together closely. Allow them to heat up without exerting any further pressure. Once the heating time has elapsed, move the tools apart, remove the welding device, and fit together the fitting and the pipe.
9. Observe the required cooling time.



SYSTEM DESCRIPTION

TRANSPORTATION AND STORAGE

DRINKING WATER HYGIENE

SYSTEM REQUIREMENTS

PLANNING AND DESIGN

WELDING TECHNOLOGY

ASSEMBLY GUIDELINES

INITIAL OPERATION

QUALITY MANAGEMENT

# WELDING TECHNOLOGY

SYSTEM DESCRIPTION

TRANSPORTATION AND STORAGE

DRINKING WATER HYGIENE

SYSTEM REQUIREMENTS

PLANNING AND DESIGN

WELDING TECHNOLOGY

ASSEMBLY GUIDELINES

INITIAL OPERATION

QUALITY MANAGEMENT

## 6.2.3 Welding saddle for 40–110 mm

### 6.2.3.1 Area of use

- subsequent extension of existing pipe systems
- alternative use instead of tees
- direct branching of a service line to a supply line
- simple assembly of sensor sleeves

### 6.2.3.2 Processing steps

1. Before you start the work, prepare material and tools. Ensure that the welding saddle, the drill and the welding tool have the same diameters.
2. Uncover the pipe at the exact location where the welding saddle is supposed to be welded, and mark the welding area. Drain existing pipes and vent the pressure.
3. Prepare the welding device and the saddle welding tools for the polyfusion welding and heat to operating temperature (250 to 270 °C).
4. Drill through the marked pipe wall with the POLYMELT Plastic Drill and clear any cuttings from the drill hole.
5. The parts and areas to be welded must be clean and dry.
6. Push the welding plate into the hole in the wall of the pipe using a suitable and aligned saddle tool, until the tool reaches its stop position. At the same time the weld-in saddle must be pushed in, until the saddle surface reaches the camber of the tool.
7. The heating time for the pipe and fittings for the drilled hole dimensions DN 25 and 32 mm is 25 seconds for all dimensions.
8. Once the heating time has elapsed, remove the welding device, push the heated weld-in saddle straight into the heated hole as far as it will go without turning it, and hold the pipe in position for at least 20 seconds applying the necessary pressure.
9. After a cooling period of at least 10 minutes, the connection can withstand a full load.



# WELDING TECHNOLOGY

## 6.2.4 Repair plugs

### 6.2.4.1 Area of use

- the repair of punctured (drilled) pipes

### 6.2.4.2 Processing steps

1. Drain pipes.
2. Uncover damaged pipe.
3. Drill damaged area of pipe out to a diameter of 8 mm at a right angle to the pipe.
4. Heat up drill hole and repair plug with POLYMUTAN hole welding tool for 15 seconds.
5. Insert repair plug immediately.
6. Cut off protruding end of repair plug.
7. The repaired area of pipe has reached full strength after approx. 5 minutes.



SYSTEM  
DESCRIPTION

TRANSPORTATION  
AND STORAGE

DRINKING WATER  
HYGIENE

SYSTEM  
REQUIREMENTS

PLANNING AND  
DESIGN

WELDING  
TECHNOLOGY

ASSEMBLY  
GUIDELINES

INITIAL  
OPERATION

QUALITY  
MANAGEMENT

# WELDING TECHNOLOGY

SYSTEM DESCRIPTION

TRANSPORTATION AND STORAGE

DRINKING WATER HYGIENE

SYSTEM REQUIREMENTS

PLANNING AND DESIGN

WELDING TECHNOLOGY

ASSEMBLY GUIDELINES

INITIAL OPERATION

QUALITY MANAGEMENT

## 6.2.5 Use of electric welding sockets

### 6.2.5.1 Area of use

- welding in constrained positions and in areas with restricted space
- repair welding
- alternative processing option for large pipe dimensions

### 6.2.5.2 Preparation

#### 1. General information and controls

Cleanliness – besides the correct operation – is the most important requirement for achieving good welding results! For the sockets to stay thoroughly clean, they need to be left in the original packaging until they are used. Furthermore, the surface of the pipe must be clean and undamaged. Incorrectly collapsed pipe ends must be cut off. We recommend PP-cleaner or cloths with ethyl alcohol for cleaning.

The pipe elements to be welded as well as the electric socket and the welding equipment must show precisely the same temperature level within the permitted temperature range (i. e. + 5 °C to 40 °C according to DVS 2207). (UV radiation or improper storage, to name two examples, can cause significant differences in temperature, which will result in faulty welding.)

#### 2. Preparatory work

It is absolutely mandatory to maintain the order of the working steps!

1. Cut pipe ends at a right angle and burr them (control carved ends).
2. Remove any dirt from the pipe ends at the required length and dry them.
3. Mark the insertion depth of the electro-welded sockets at the pipe end.
4. Use a pipe scraper to remove the oxide film from the entire exposed pipe surface down to the marked insertion depth.
5. Clean thoroughly using ethyl alcohol. A homogeneous and impermeable welded connection can only be established, if the surface in the welding range is peeled and cleaned comprehensively.

Do not touch peeled pipe ends again and protect them from new contamination – e. g. put a clean plastic bag over them. Weld within 30 minutes after the peeling process.

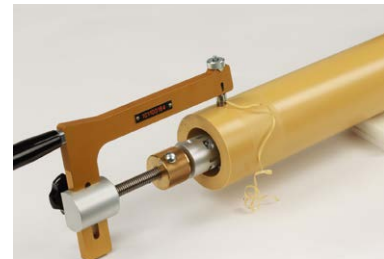

#### 3. Assembly of the electric welding socket

1. Carefully clean the inner surface of the socket using lint-free cloth. Mount the socket within 30 minutes after opening the packaging.
2. Slide the electric welding socket onto the clean and dry pipe end until you reach the marked insertion depth.
3. Completely remove the protective foil and slide the peeled and clean second pipe end into the electric welding socket.

Contaminations are to be avoided diligently and all parts must be securely fastened. Pipes must be free of flexural strain or self-weight when they are inserted into the electric welding socket. The socket should still be able to move the pipe ends after the mounting process. The air gap must be evenly distributed around the circumference. A joint that is not free of tension or that has shifted can result in undesired molten mass or in an inadequate connection. The pipe ends and welded sockets must be dry when mounted.

# WELDING TECHNOLOGY

## 4. Welding process

1. Position the socket so that the air gap is evenly distributed around the circumference.
2. Set the welding equipment to the diameter of the welding socket.
3. Compare the data on the welding equipment's display screen with the details on the label; enter the required code manually or by scanning it (see barcode label on the electric welding socket).
4. Start the welding process and monitor it closely.



The joint must not be moved or put under external pressure during the entire welding process, until it has completely cooled off! Once the welded connection has been successfully established, two pins remain visible as an outward sign.



## 5. Cooling-off time and pressure test

The welded pipe joint may only be put under pressure or moved, and the fastening may only be loosened once the cooling-off period has elapsed!

The minimum required cooling-off time is marked on the electric welding sockets. In case of ambient temperatures above 25 °C or when there is strong solar radiation, the cooling-off time must be extended accordingly!

In order to achieve an ideal and stable welding result, both pipe ends must be plane-parallel within the electric welding socket! It is imperative to mark the socket insertion depth on the pipe, and to adhere to it!

Type of strain	Compression strain	Minimum waiting period
Tension, bending, torsion of unpressurised pipelines		20 minutes
Testing or working pressure of pressurised pipelines	up to 0.1 bar	20 minutes
	0.1 bar to 1 bar	60 minutes
	over 1 bar	120 minutes
Repetition of welding process		60 minutes

SYSTEM DESCRIPTION

TRANSPORTATION AND STORAGE

DRINKING WATER HYGIENE

SYSTEM REQUIREMENTS

PLANNING AND DESIGN

WELDING TECHNOLOGY

ASSEMBLY GUIDELINES

INITIAL OPERATION

QUALITY MANAGEMENT



# ASSEMBLY GUIDELINES

SYSTEM  
DESCRIPTION

## 7.1 Fastening techniques

A pipe fastening system that complies with regulations is subject to the following requirements:

- The fastening system must absorb any forces that may occur.
- The external impact upon pipes and fittings, caused e.g. by sagging, changes in length, mechanical load, must be prevented by applying appropriate fastening techniques.
- The pipework must be held firmly in the intended position.

TRANSPORTATION  
AND STORAGE

The fastening mechanism must be selected in accordance with the outside diameter of the pipe due to be fixed into position. Take appropriate measures to ensure that the pipe surface cannot be damaged by any of the pipe fastening elements.

DRINKING WATER  
HYGIENE

Experience has shown that pipe clamps with rubber inserts represent the ideal fastening mechanism for POLYMELT installation systems. In the selection of suitable fastening materials, we generally differentiate between fixed bearings and slide or guide bearings.

SYSTEM  
REQUIREMENTS

### 7.1.1 Fixed points

- Fixed points are determined to divide the pipe line into individual sections, which helps to avoid uncontrolled pipe movement.
- These fixed points need to be designed so as to compensate for the expansion forces arising from the pipe and possibly existing additional loads.
- Short distances in the ceiling should be chosen as the clamp and the fastening element need to be fastened tightly because of the forces that arise here.

PLANNING AND  
DESIGN

### 7.1.2 Sliding points

- They have to compensate for the axial pipe movement without causing any damage.
- When positioning the sliding points, care must be taken that no fittings or fixtures obstruct the pipeline movement.

WELDING  
TECHNOLOGY

ASSEMBLY  
GUIDELINES

INITIAL  
OPERATION

QUALITY  
MANAGEMENT



# ASSEMBLY GUIDELINES

## 7.2 Mounting distances

Tables for the determination of the distance between clamps, depending on temperature and outside diameter. The values specified are POLYMELT recommendations, and are valid for horizontal and vertical installations.

### POLYMUTAN pipes SDR 6, SDR 7.4, SDR 11

Table 17

Dimension in mm	Media temperature [°C]						
	10	20	30	40	50	60	70
	Mounting distances [cm]						
20	80	70	65	65	65	60	60
25	90	80	75	75	75	70	70
32	100	90	85	85	85	80	80
40	110	100	95	95	95	90	90
50	140	120	115	110	105	100	100
63	160	140	130	125	120	110	110
75	180	150	140	135	130	120	120
90	210	160	150	150	140	130	130
110	240	180	170	160	150	140	140

### POLYMUTAN pipes with pipe supports SDR 6, SDR 7.4, SDR 11

Dimension in mm	Media temperature [°C]	
	10	70
	Mounting distances [cm]	
20	170	150
25	200	180
32	220	200
40	230	210
50	230	230
63	230	230
75	230	230
90	230	230
110	230	230

SYSTEM DESCRIPTION

TRANSPORTATION AND STORAGE

DRINKING WATER HYGIENE

SYSTEM REQUIREMENTS

PLANNING AND DESIGN

WELDING TECHNOLOGY

ASSEMBLY GUIDELINES

INITIAL OPERATION

QUALITY MANAGEMENT

# ASSEMBLY GUIDELINES

## POLYMUTAN ML5 pipes, SDR 7.4

Dimension in mm	Media temperature [°C]						
	10	20	30	40	50	60	70
	Mounting distances [cm]						
20	110	95	90	85	85	80	70
25	120	105	105	95	95	90	80
32	140	120	120	110	110	105	95
40	160	140	135	125	125	120	110
50	185	155	155	145	145	135	130
63	200	175	175	165	165	155	145
75	215	190	190	175	175	165	155
90	230	210	210	195	195	180	180
110	250	220	220	210	200	200	190

## 7.3 Laying the pipes

In the case of pipes laid in walls and ceilings, the friction forces that occur prevent the expansion of the pipes, and therefore no compensation is necessary. The resulting tension is absorbed by the pipe materials.

Due to the low expansion forces, the masonry or the plaster are not damaged.

### Installing pipes in a shaft

- Changes in length can be disregarded if pipes are laid in a vertical shaft.
- It will be sufficient to mount a fixed-point clamp ahead of every branching; in a rising pipe, all clamps are fixed points.
- Rising pipes can be laid without expansion elbows.
- The distance between two fixed points must not be greater than 3 m.

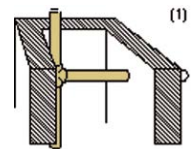

### Open laying of pipes

- Such pipes need to be laid using fixed and slide points. This will ensure sufficient space for the pipe to expand.
- If the line length equals or exceeds 40 m, expansion must be compensated for using bending legs and angles.

### Concealed laying

- No precautions required.

# ASSEMBLY GUIDELINES

## 7.4 Length variation

Changes in the length of pipes are dependent on the increasing temperature of the pipe material. This temperature change can be caused by different installation and operating temperatures, as well as varying media temperatures. The potential variation in length must be taken into account at the time of installation.

If the operating temperature is higher than the installation temperature, the pipe will elongate. If the media temperature (e.g. cold water) is lower than the installation temperature, the calculation will result in a reduction in length.

The following factors must be considered in the calculation of the variation in length:

- installation temperature
- operating temperatures (media temperatures)
- temperature difference between installation and operating temperatures
- coefficient of linear expansion
- pipe length

The coefficient of linear expansion  $\alpha$  for POLYMUTAN pipes are:

- POLYMUTAN pipe  $\alpha = 0.15 \text{ mm/mK}$
- POLYMUTAN pipe with pipe support  $\alpha = 0.05 \text{ mm/mK}$
- POLYMUTAN ML5 pipe  $\alpha = 0.038 \text{ mm/mK}$

The formula for the calculation of the variation in length is:

$\Delta L = \alpha \times l_0 \times \Delta T$		
$\Delta L$	variation in length	mm
$l_0$	pipe length prior to temperature change	m
$\alpha$	length variation coefficient	$\frac{\text{mm}}{\text{m} \times \text{K}}$
$\Delta T$	maximum occurring temperature difference between installation and operating temperature	K

Example:  
 POLYMUTAN SDR 6  
 Length: 14 m  
 Installation temperature: 20 °C  
 Operating temperature: 60 °C

$$l = 0.15 \frac{\text{mm}}{\text{m} \times \text{K}} \times 14 \text{ m} \times (60 - 20) \text{ K}$$

$$l = 84 \text{ mm}$$

Calculation with ML5 Pipe:  
 $l = 21.28 \text{ mm}$

SYSTEM DESCRIPTION

TRANSPORTATION AND STORAGE

DRINKING WATER HYGIENE

SYSTEM REQUIREMENTS

PLANNING AND DESIGN

WELDING TECHNOLOGY

ASSEMBLY GUIDELINES

INITIAL OPERATION

QUALITY MANAGEMENT

# ASSEMBLY GUIDELINES

Linear expansion tables

Table 20

POLYMUTAN pipe		difference in temperature $\Delta T$ (K)							
pipe length in meters (m)	10	20	30	40	50	60	70	80	
	1.0	1.5	3.0	4.5	6.0	7.5	9.0	10.5	12.0
2.0	3.0	6.0	9.0	12.0	15.0	18.0	21.0	24.0	
3.0	4.5	9.0	13.5	18.0	22.5	27.0	31.5	36.0	
4.0	6.0	12.0	18.0	24.0	30.0	36.0	42.0	48.0	
5.0	7.5	15.0	22.5	30.0	37.5	45.0	52.5	60.0	
6.0	9.0	18.0	27.0	36.0	45.0	54.0	63.0	72.0	
7.0	10.5	21.0	31.5	42.0	52.5	63.0	73.5	84.0	
8.0	12.0	24.0	36.0	48.0	60.0	72.0	84.0	96.0	
9.0	13.5	27.0	40.5	54.0	67.5	81.0	94.5	108.0	
10.0	15.0	30.0	45.0	60.0	75.0	90.0	105.0	120.0	
15.0	22.5	45.0	67.5	90.0	112.5	135.0	157.5	180.0	
20.0	30.0	60.0	90.0	120.0	150.0	180.0	210.0	240.0	
25.0	37.5	75.0	112.5	150.0	187.5	225.0	262.5	300.0	
30.0	45.0	90.0	135.0	180.0	225.0	270.0	315.0	360.0	
35.0	52.5	105.0	157.5	210.0	262.5	315.0	367.5	420.0	
40.0	60.0	120.0	180.0	240.0	300.0	360.0	420.0	480.0	
45.0	67.5	135.0	202.5	270.0	337.5	405.0	472.5	540.0	
50.0	75.0	150.0	225.0	300.0	375.0	450.0	525.0	600.0	
linear expansion $\Delta L$ in mm									

Table 21

POLYMUTAN pipe with pipe support		difference in temperature $\Delta T$ (K)							
pipe length in meters (m)	10	20	30	40	50	60	70	80	
	1.0	0.5	1.0	1.5	2.0	2.5	3.0	3.5	4.0
2.0	1.0	2.0	3.0	4.0	5.0	6.0	7.0	8.0	
3.0	1.5	3.0	4.5	6.0	7.5	9.0	10.5	12.0	
4.0	2.0	4.0	6.0	8.0	10.0	12.0	14.0	16.0	
5.0	2.5	5.0	7.5	10.0	12.5	15.0	17.5	20.0	
6.0	3.0	6.0	9.0	12.0	15.0	18.0	21.0	24.0	
7.0	3.5	7.0	10.5	14.0	17.5	21.0	24.5	28.0	
8.0	4.0	8.0	12.0	16.0	20.0	24.0	28.0	32.0	
9.0	4.5	9.0	13.5	18.0	22.5	27.0	31.5	36.0	
10.0	5.0	10.0	15.0	20.0	25.0	30.0	35.0	40.0	
15.0	7.5	15.0	22.5	30.0	37.5	45.0	52.5	60.0	
20.0	10.0	20.0	30.0	40.0	50.0	60.0	70.0	80.0	
25.0	12.5	25.0	37.5	50.0	62.5	75.0	87.5	100.0	
30.0	15.0	30.0	45.0	60.0	75.0	90.0	105.0	120.0	
35.0	17.5	35.0	52.5	70.0	87.5	105.0	122.5	140.0	
40.0	20.0	40.0	60.0	80.0	100.0	120.0	140.0	160.0	
45.0	22.5	45.0	67.5	90.0	112.5	135.0	157.5	180.0	
50.0	25.0	50.0	75.0	100.0	125.0	150.0	175.0	200.0	
linear expansion $\Delta L$ in mm									

# ASSEMBLY GUIDELINES

## Linear expansion tables

Table 22

POLYMUTAN ML5. UV ML5								
pipe length in meters (m)	difference in temperature $\Delta T$ (K)							
	10	20	30	40	50	60	70	80
1.0	0.4	0.8	1.1	1.5	1.9	2.3	2.7	3.0
2.0	0.8	1.5	2.3	3.0	3.8	4.6	5.3	6.1
3.0	1.1	2.3	3.4	4.6	5.7	6.8	8.0	9.1
4.0	1.5	3.0	4.6	6.1	7.6	9.1	10.6	12.2
5.0	1.9	3.8	5.7	7.6	9.5	11.4	13.3	15.2
6.0	2.3	4.6	6.8	9.1	11.4	13.7	16.0	18.2
7.0	2.7	5.3	8.0	10.6	13.3	16.0	18.6	21.3
8.0	3.0	6.1	9.1	12.2	15.2	18.2	21.3	24.3
9.0	3.4	6.8	10.3	13.7	17.1	20.5	23.9	27.4
10.0	3.8	7.6	11.4	15.2	19.0	22.8	26.6	30.4
15.0	5.7	11.4	17.1	22.8	28.5	34.2	39.9	45.6
20.0	7.6	15.2	22.8	30.4	38.0	45.6	53.2	60.8
25.0	9.5	19.0	28.5	38.0	47.5	57.0	66.5	76.0
30.0	11.4	22.8	34.2	45.6	57.0	68.4	79.8	91.2
35.0	13.3	26.6	39.9	53.2	66.5	79.8	93.1	106.4
40.0	15.2	30.4	45.6	60.8	76.0	91.2	106.4	121.6
45.0	17.1	34.2	51.3	68.4	85.5	102.6	119.7	136.8
50.0	19.0	38.0	57.0	76.0	95.0	114.0	133.0	152.0
linear expansion $\Delta L$ in mm								

## 7.5 Thermal expansion force

The following formula can be used to calculate the thermal expansion force:

$$F_t = \frac{E \times A \times \alpha \times \Delta T}{1000}$$

$F_t$  = thermal expansion force [N]

$E$  = modulus of elasticity (modulus of rigidity) [MPa = N/mm<sup>2</sup>]

$A$  = cross-sectional area of the pipe in [mm<sup>2</sup>]

$\alpha$  = specific thermal expansion coefficient [mm/(mK)]

$\Delta T$  = temperature difference resulting from media temperature minus laying temperature [K]

Material	Pipe dimension	Modulus of elasticity	Coefficient of linear expansion	Thermal Expansion Force
Steel	26.9 × 2.65	220,000	0.012	533
High-grade steel	22.0 × 1.2	200,000	0.015	235
Copper	22.0 × 1.0	130,000	0.016	137
Prostab	25.0 × 3.5	3,500	0.035	29
PVC	25.0 × 3.2	1,100	0.08	19
PP-R / PP RCT	25.0 × 4.2	900	0.150	12
PE-X	25.0 × 3.5	540	0.175	22
PE-RT	25.0 × 3.5	250	0.180	10
PE-X / Alu	26.0 × 3.0	3,500	0.030	22

# ASSEMBLY GUIDELINES

SYSTEM DESCRIPTION

This comparison shows that the thermal expansion forces occurring in plastic pipes are extremely low, compared to pipes made of metallic materials

TRANSPORTATION AND STORAGE

If the thermal expansion force is countered by a corresponding retention force, the expansion can be neutralised effectively.

DRINKING WATER HYGIENE

SYSTEM REQUIREMENTS

PLANNING AND DESIGN

WELDING TECHNOLOGY

ASSEMBLY GUIDELINES

INITIAL OPERATION

QUALITY MANAGEMENT



## 7.6 Expansion compensation

Variations in length caused by temperature differences must be taken into account during the planning stage to prevent subsequent damage to pipelines, fastening elements and the building structure. In order to keep the occurring stress impacts within acceptable ranges, the variation in length must be compensated appropriately. There are two options available to achieve this compensation:

- Expansion compensation using bending legs and a U-pipe bends (“natural” expansion compensation)
- Expansion compensation using compensators (“artificial” expansion compensation)

In most cases, directional changes in the pipe routing can be utilised to absorb the variation in length. Should the directional changes not be sufficient, a U-pipe bend must be used.

It is important to bear in mind that the outlets distributed throughout the line system can also influence the variation in length, or may be negatively affected themselves by the variation in length.

Please refer to the manufacturers of the compensators for more information on the expansion compensation provided by compensators.

### 7.6.1 Bending legs

In order to determine the specific direction in which the expansion compensation is steered, the directional change is installed between two fixed points. Generally, the pipes are arranged in right angles at the points where the direction changes. A variation in the length of one leg produces bending in the other leg. Provided that all legs are of a sufficient length to prevent the resulting flexural strain from becoming too great, the system can flexibly absorb the variation in length.

$l_B = K \times \sqrt{d \times \Delta L}$		
$l_B$	length of the bending leg	mm
K	material-dependent constant (15.0 for PP)	
d	outside pipe diameter	mm
$\Delta L$	variation in length	mm

Sample calculation:  
 Pipe outside diameter 75 mm  
 Variation in length 84 mm

$$l_B = 15 \times \sqrt{75 \text{ mm} \times 84 \text{ mm}}$$

$$l_B = 1191 \text{ mm}$$

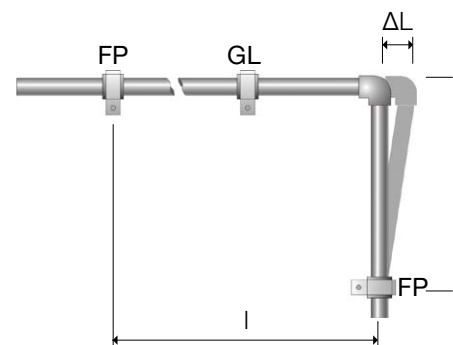

# ASSEMBLY GUIDELINES

## 7.6.2 Expansion loop

If it is not possible to compensate for the variation in length by introducing directional changes into the pipe routing, an expansion loop must be used instead.

For the implementation of the expansion loop, the length  $l_B$  of the bending leg and the width  $b_{min}$  of the expansion loop must be considered. It is advisable to position the expansion loop in such a way that the lengths  $l_1$  and  $l_2$  are equal.

$b_{min} = 2 \times \Delta L + SA$		
$b_{min}$	minimum width of the expansion	mm
$\Delta L$	variation in length	mm
SA	safety clearance = 150	mm

Sample calculation:  
Variation in length  $\Delta L = 84$  mm

$$b_{min} = 2 \times 84 \text{ mm} + 150 \text{ mm}$$

$$b_{min} = 318 \text{ mm}$$

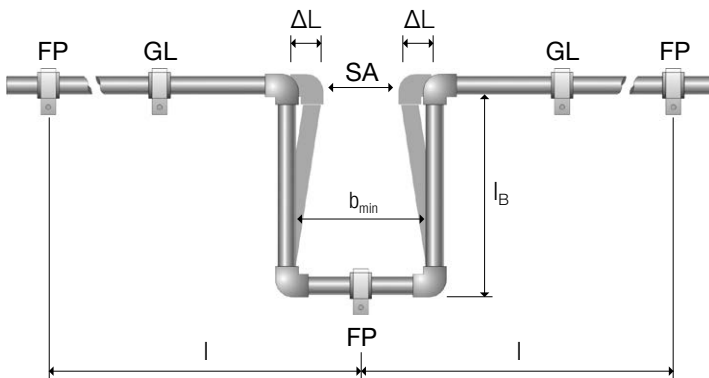

## 7.6.3 Pre-tensioning

If, during installation, an expansion loop is already pre-stretched by the length  $\Delta L_v$  against the subsequent length variation and is thus “pre-tensioned”, the length of the bending leg  $l_{BV}$  can be reduced.

$l_{BV} = l_B \times \sqrt{1 - \frac{\Delta L_v}{\Delta L}}$		
$\Delta L_v$	variation in length with pre-tensioning	mm
$\Delta L$	variation in length	mm
$l_{BV}$	length of bending leg with pre-tensioning	mm
$l_B$	length of bending leg	mm

Sample calculation:  
Variation in length  $\Delta L = 84$  mm  
Pre-tensioning  $\Delta L_v = 42$  mm

$$l_{BV} = 1191 \text{ mm} \times \sqrt{1 - \frac{42}{84}}$$

$$l_{BV} = 842 \text{ mm}$$

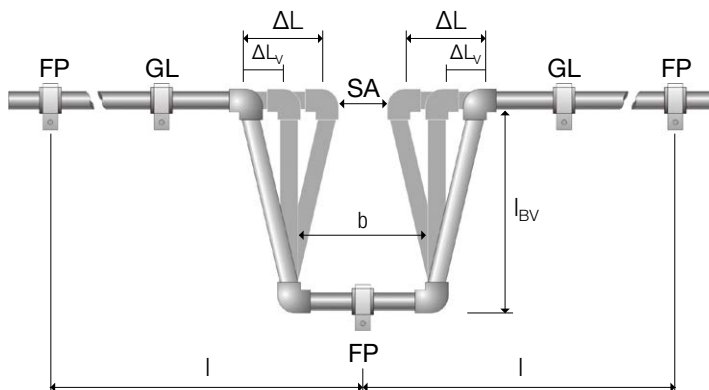

# ASSEMBLY GUIDELINES

## 7.7 Insulation

The EnEV (German Energy Saving Regulation) standard regulates the thermal insulation of pipelines and fittings within the Federal Republic of Germany. The purpose of the pie insulation is to:

- Protect the pipes against condensation
- Protect the cold water pipes against exposure to heat
- Minimize heat losses
- Reduce the transfer of heat to structural components
- Reduce sound transmission
- Protect against UV radiation
- Absorb variations in length caused by temperature
- Protect against mechanical stresses
- Protect against corrosion

### 7.7.1 Hot water insulation

#### Requirements according to EnEV

Table 24: Thermal insulation of heat distribution and hot water pipelines as well as fittings.

Table 24

Line	Type of pipeline / valves and fittings	Minimum thickness of the insulation layer, based on a thermal conductivity of 0.035 W/(m K)
1	Inner diameter up to 22 mm	20 mm
2	Inner diameter above 22 mm up to 35 mm	30 mm
3	Inner diameter above 35 mm up to 100 mm	equal to inner diameter
4	Inner diameter above 100 mm	100 mm
5	Pipes, valves and fittings acc. to lines 1 to 4 in wall and ceiling breaks, at the intersection of lines, at line connection points, at central mains system switches	½ of the requirements listed in lines 1 to 4
6	Central heating pipes acc. to lines 1 to 4, that have been installed in buildings between heated rooms of various users since January 31, 2002	½ of the requirements listed in lines 1 to 4
7	Pipes acc. to line 6 installed in floor constructions	6 mm
8	Cold distribution and cold water pipes as well as fittings for ventilation and cooling systems	6 mm

When using materials with thermal conductivity values other than 0.035 W/(m K), the minimum thickness values of the insulation layers must be converted accordingly. The calculation methods and values contained within accepted engineering standards must be employed for the conversion and the thermal conductivity of the insulation material.

In the case of heat distribution and hot water pipes, as well as cold distribution and cold water pipes, the minimum thickness values of the insulation layers listed in Table 5 may be reduced to the extent of the equivalent limitation of heat absorption or loss, and the insulating effect of the pipe walls must be taken into account.



# ASSEMBLY GUIDELINES

## 7.7.2 Cold water insulation

Guide values for the minimum thickness of insulating layers used to insulate cold drinking water systems against heat and condensation.

### Insulation layer thickness acc. to DIN 1988-200, Table 16

Table 16

Installation situation	Insulation layer thickness at $\lambda = 0.040 \text{ W/mK}^*$
Exposed pipes in unheated rooms (e.g. basement)	9 mm
Exposed pipes in heated rooms	13 mm
Pipes installed in a duct, without pipes carrying high-temperature media	13 mm
Pipes installed in a duct, alongside pipes carrying high-temperature media	13 mm
Pipes installed in wall slots, rising pipes	4 mm
Pipes installed in wall recesses, alongside pipes carrying high-temperature media	13 mm
Pipes installed on concrete floor (also alongside non-circulating hot water lines)	4 mm

\*) If materials with different thermal conductivity coefficients are used, the insulation layer thickness must be converted accordingly in relation to a pipe diameter of  $d = 20 \text{ mm}$ .

The temperature increase of drinking water is primarily influenced by the duration of stagnation, the position and arrangement of the pipes, and by the insulation used. Care must be taken during installation of pipelines to maintain a sufficient distance to all heat sources such as warm pipes, flues, and heating pipes.

In the case of standing water, even insulation measures cannot provide long-term protection against warming.

## 7.7.3 Dew point

Condensation occurs when the temperature of a surface falls below the saturation temperature of the surrounding air.

The saturation temperature of the air is determined from the current temperature and the relative humidity. The temperature of the surface is determined by the heat transfer from the material to the pipe surface, from the air to the pipe surface, and the heat transfer through the pipe wall.

### Data required in order to determine the dew point:

- Relative air humidity
- Ambient temperature
- Water temperature
- Temperature difference  $\Delta\theta$  in K (room temperature – water temperature)

Sample calculation:

At an ambient temperature of  $27 \text{ }^\circ\text{C}$ , 60 % relative humidity and  $12 \text{ }^\circ\text{C}$  water temperature the pipe begins to sweat.

- For SDR 6 pipes the maximum temperature difference is 15 K.
- For SDR 11 pipes the maximum temperature difference is 11 K.

SYSTEM DESCRIPTION

TRANSPORTATION AND STORAGE

DRINKING WATER HYGIENE

SYSTEM REQUIREMENTS

PLANNING AND DESIGN

WELDING TECHNOLOGY

ASSEMBLY GUIDELINES

INITIAL OPERATION

QUALITY MANAGEMENT

# ASSEMBLY GUIDELINES

SYSTEM DESCRIPTION

TRANSPORTATION AND STORAGE

DRINKING WATER HYGIENE

SYSTEM REQUIREMENTS

PLANNING AND DESIGN

WELDING TECHNOLOGY

ASSEMBLY GUIDELINES

INITIAL OPERATION

QUALITY MANAGEMENT

Diagram for the determination of the dew point for POLYMUTAN SDR 6

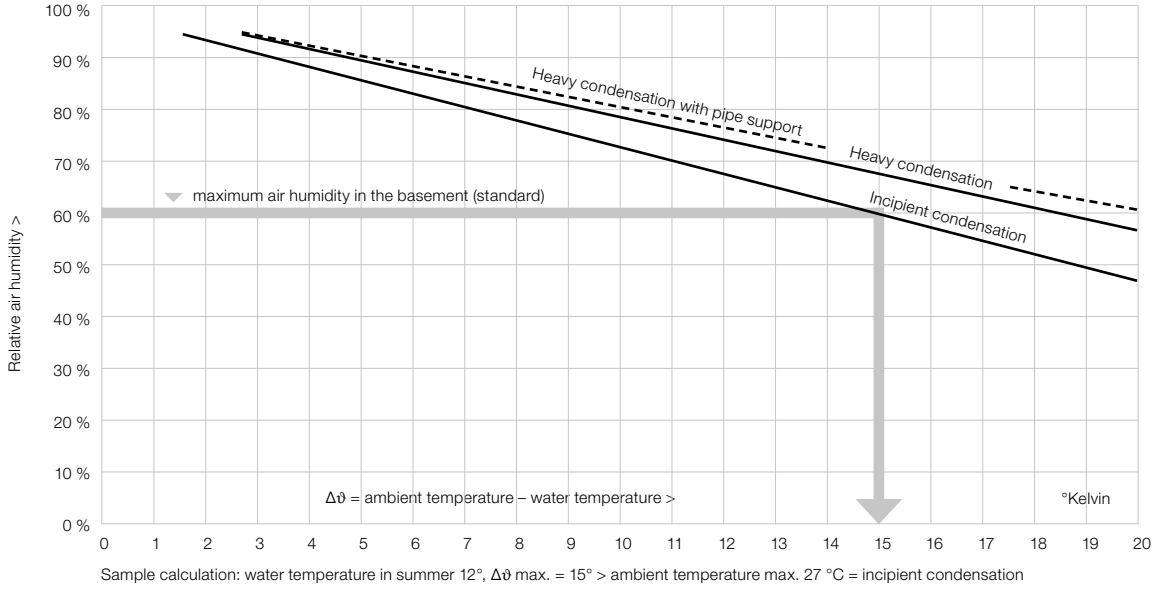
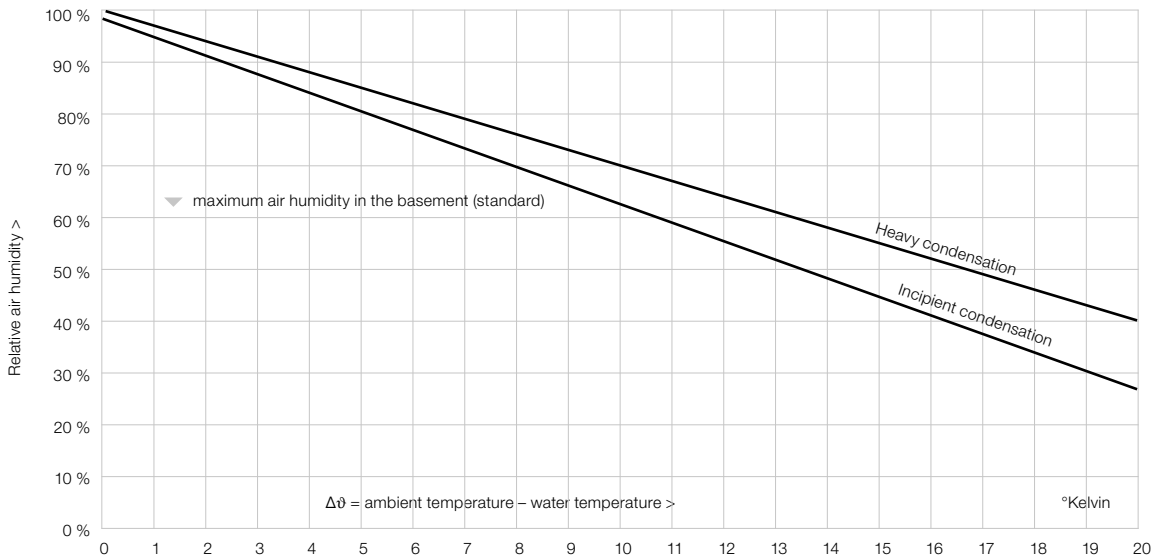

Diagram for the determination of the dew point for POLYMUTAN SDR 11



# ASSEMBLY GUIDELINES

## 7.8 Noise protection

In order to prevent the transmission of structure-borne noise from the pipe system to the building, sound insulation preventing structure-borne sound must be applied to the pipes. This can be achieved through tape bindings, insulating hoses or through sheathed half-shells. This type of insulation dampens the transmission of flow noise as well as noises from machine parts (pumps) to the structural components surrounding the pipes. Standard DIN 4109 with Supplementary Table A1 regulates the minimum requirements of sound insulation in buildings, given varying requirements and taking into account the source of noise. The following sound pressure levels in dB(A) are admissible.

Admissible sound pressure levels in rooms requiring sound protection against noise from building services and commercial enterprises

Table 26

Source of noise	Characteristic sound pressure level dB(A) in	
	Living rooms and bedrooms	Teaching and working spaces
Plumbing applications (both water supply- and wastewater systems)	≤ 30 <sup>1) 2)</sup>	≤ 35 <sup>1) 2)</sup>
Other building services systems	≤ 30 <sup>3)</sup>	≤ 35 <sup>3)</sup>
Businesses during the day 6 a.m. to 10 p.m.	≤ 35	≤ 35 <sup>3)</sup>
Businesses during the night 10 p.m. to 6 a.m.	≤ 25	≤ 35 <sup>3)</sup>

- <sup>1)</sup> Single, short-term spikes that occur when operating valves and devices in accordance with Table 6 DIN 4109 (opening, closing, adapting, interrupting, etc.) can be disregarded at this time.
- <sup>2)</sup> Conditions stipulated in the contract for work to meet the admissible installation sound pressure level:
- The construction documents must take into account the requirements of noise protection, which means that – amongst other requirements to be observed – the necessary sound insulation certificates must be provided for the components used.
  - Furthermore, construction management must be named and involved before an installation is closed in or covered. Further details are regulated by the ZVSHK Bulletin (Central Association for Plumbing, Heating, Air Conditioning).
- <sup>3)</sup> In the case of ventilation systems the values are permitted to be 5 dB(A) higher, provided that the noise is constant noise, without distinct audible sounds.

SYSTEM  
DESCRIPTION

TRANSPORTATION  
AND STORAGE

DRINKING WATER  
HYGIENE

SYSTEM  
REQUIREMENTS

PLANNING AND  
DESIGN

WELDING  
TECHNOLOGY

ASSEMBLY  
GUIDELINES

INITIAL  
OPERATION

QUALITY  
MANAGEMENT

# ASSEMBLY GUIDELINES

## 7.9 Fire protection

The POLYMUTAN installation system is classified as follows:

Standard	Classification
EN 13501	E
DIN 4102	B2

### EN 13501 and DIN 4102

These standards define the classification of those materials, which are used as products or as product components in building construction. The fire behaviour of the products used is tested and classified by testing the behaviour in the case of fire, e.g. the development and spread of fire and smoke.

### The behaviour of PP-R in the case of fire

Pipes and fittings made of PP-R, PP-RCT and with fibres, do not exhibit an increased conflagration gas toxicity. In construction objects with a greater need for fire protection measures, pipe ducts through walls and ceilings must be protected against fire in such a way that, as a general principle, all pipe ducts have the same classification as the structural components through which the ducts lead.

For example: In the case of a wall, which features a fire resistance period of 90 minutes (F90), the pipe ducting must also have a fire resistance period of 90 minutes (R 90).

All fire protection systems that have been issued with a corresponding accreditation can be used with POLYMUTAN pipes.

One possible solution is the fire protection measure using fire protection collars or special mineral insulation with a melting temperature of > 1,000 °C.



BSM F

### Fire load

The resulting combustion heat V(kWh/m) of POLYMUTAN pipes is dependent on the pipe dimension. The basis for the calculation of the combustion heat V for POLYMUTAN pipes made of PP-R is given by the lower calorific value  $H_u = 12.2 \text{ kWh/kg}$  (acc. to DIN 18230 Section 1), as well as the material mass m (kg/m).

Combustion values V (kWh/m) of POLYMUTAN pipes, Table 17

Table 17

Outer diameter	PP R		
	SDR 11	SDR 6	SDR 7.4
20	1.31	2.1	1.80
25	2	3.25	2.79
32	3.25	5.3	4.44
40	5.03	8.19	6.95
50	7.78	12.81	10.84
63	12.32	20.13	17.05
75	17.32	28.55	24.25
90	24.77	41	34.76
110	36.72	61.49	51.88
125	47.54	77.84	

# ASSEMBLY GUIDELINES

## 8.1 Pressure-tests

Upon completion of the installation work, drinking water installations inside buildings must be subjected to hydraulic pressure testing. This must be carried out while the pipe system is fully accessible. In accordance with DIN EN 806, the test can be carried out using water or, if national regulations permit, with oil-free clean air at low pressure or inert gases.

The choice of method to be applied must take into account the factors relating to hygiene and corrosion, and must be determined in relation to the design of the system and the time schedule of the construction project.

In order to pressure-test using water, the completed pipelines must be gradually filled with drinking water that does not contain particles  $\geq 150 \mu\text{m}$ , and must then be vented. The drinking water system must be put into operation immediately after the pressure test with water and the subsequent flushing of the system. If this is not possible, the flushing process must be repeated regularly, with no more than 7 days between repetitions. If the system is due to be put into operation at a later stage, in the interest of hygiene, the pressure test should be conducted with air or inert gas as a testing medium.

Due to the characteristic properties of the materials used, plastic pipes expand for a limited period of time when they are subjected to pressure. This has an impact on the test result. A change in the temperature in a pipe system can lead to a change in pressure in the case of pipes made of plastic.

Consequently, pressure testing should follow the protocols provided below (page 86 and following).

Once the pressure tests have been completed, the responsible technician must produce a formal record, which includes an assessment of the test. The impermeability of the system must be evident, and must be confirmed in writing.

### Pressure testing with water

DIN EN 806-4 stipulates that there are three possible pressure tests, depending on the different material properties. Due to issues concerning the practical feasibility on site, and following practical experiments, a modified method was selected, which is suitable for all materials and all material combinations.

The duration of the test was extended beyond the period stipulated in the standard, to ensure that even the smallest possible leaks can be detected during the leak test.

### Pressure testing with air

As gases are compressible, when carrying out pressure testing using air, the accident prevention regulations "Working on Gas Installations" and the guidelines "Technical Rules for Gas Installations DVGW-TRGI" must be observed for physical and safety reasons. Therefore, acting in agreement with the responsible professional association and in observance of this body of rules, the testing pressures were fixed at a maximum of 0.3 MPa (3bar), corresponding to the stress and leak tests for gas lines. This fully complies with the national regulations.

The volume in the pipe system has a significant impact on the pressure results shown. Changes in temperature can also influence the test results. A high pipe system volume can have a negative impact on the determination of minor leaks using drops in pressure. Consequently, it can be helpful to divide the test into small sections, in order to achieve the best possible testing safety and accuracy.

SYSTEM  
DESCRIPTION

TRANSPORTATION  
AND STORAGE

DRINKING WATER  
HYGIENE

SYSTEM  
REQUIREMENTS

PLANNING AND  
DESIGN

WELDING  
TECHNOLOGY

ASSEMBLY  
GUIDELINES

INITIAL  
OPERATION

QUALITY  
MANAGEMENT

# INITIAL OPERATION

SYSTEM DESCRIPTION

TRANSPORTATION AND STORAGE

DRINKING WATER HYGIENE

SYSTEM REQUIREMENTS

PLANNING AND DESIGN

WELDING TECHNOLOGY

ASSEMBLY GUIDELINES

INITIAL OPERATION

QUALITY MANAGEMENT

## Pressure testing protocol, testing media: water

Construction project: .....

Construction stage: .....

Client represented by: .....

Contractor represented by: .....

Admissible operating pressure = 10 bar .....bar (if higher)

Water temperature ..... °C Ambient temperature ..... °C

System inspection as  complete system  in ..... sections

Preliminary arrangements:

- The pipe system is made of PP, and, if applicable, with combined installations made of metal and multi-layer composite pipelines.
- All pipes have been sealed by metal plugs, caps, blanking plates or blank flanges.
- Equipment and valves that do not meet the required test pressure, have been separated from the lines.
- Expert laying of the piping.
- Filling water has been filtered. Filter mesh < 150 µm
- The system has been filled, flushed and de-aerated.

### Leak Test

	TESTING METHOD	RESULTS	NOTE
<input type="checkbox"/>	Preliminary test Test pressure 15 bar Test duration 30 min	A maximum pressure drop of 0.5 bar Test pressure after 30 min ..... bar	
<input type="checkbox"/>	Main test Test pressure 10 bar Test duration 30 min	A maximum pressure drop of 0.2 bar Test pressure after 30 min ..... bar	
<input type="checkbox"/>	Final test Test pressure 10 bar Test duration 60 min	No pressure drop Test pressure after 60 min ..... bar	

- Visual inspection of pipe system has been carried out
- No leaks were determined during the testing period
- The pipe system is leak-proof

Place ..... Date .....

Client ..... Contractor .....

1) The pressure gauges used must allow a precise reading of a 0,1 bar change in pressure.

# INITIAL OPERATION

## Pressure testing protocol testing media compressed air or inert gas

Construction project: .....

Construction stage: .....

Client represented by: .....

Contractor represented by: .....

Pipe system materials: .....

System operating pressure ..... bar ambient air temperature ..... °C

Temperature of testing medium ..... °C

Testing medium  oil-free compressed air  nitrogen  carbon dioxide

System inspection as  complete system  in ..... sections

Preliminary arrangements:

- All pipes have been sealed with metal plugs, caps, blanking plates or blank flanges.
- Equipment, pressure tanks or drinking water heaters have been disconnected from the system.
- A visual inspection ensuring the professional execution of all pipe connections has been carried out.

### 1. Leak test <sup>1)</sup>

Testing pressure 150 mbar

Up to 100 litres pipe system capacity require a testing period of at least 120 minutes. For every further 100 litres, the testing period must be extended by 20 minutes.

Pipe system capacity: ..... litres Testing period: ..... minutes

The testing period starts, once the testing pressure has been reached, taking into account a waiting period for the equalization of the media temperature and the ambient temperature.

- Visual inspection of pipe system has been carried out
- Inspection by pressure gauge, U-pipe or respectively standpipe water column has been carried out <sup>1)</sup>
- No drop in pressure was determined during the testing period
- No leaks were determined during the testing period

### 2. Strength test with elevated pressure <sup>2)</sup>

Wait for temperature equalization and steady state in the case of plastic pipes; the testing period starts once these have been reached.

Testing pressure ≤ 63 mm maximum 3 bar Testing pressure > 63 mm maximum 1 bar

Testing period: 10 minutes

- No drop in pressure was determined during the testing period
- No leaks were determined during the testing period
- The pipe system is leak-proof

Place ..... Date .....

Client ..... Contractor .....

1) The pressure gauges used must allow a precise reading of a 1 mbar change in pressure.

2) The pressure gauges used must allow a precise reading of a 0.1 bar change in pressure.

SYSTEM DESCRIPTION

TRANSPORTATION AND STORAGE

DRINKING WATER HYGIENE

SYSTEM REQUIREMENTS

PLANNING AND DESIGN

WELDING TECHNOLOGY

ASSEMBLY GUIDELINES

INITIAL OPERATION

QUALITY MANAGEMENT

# INITIAL OPERATION

## 8.2 Flushing the system

On principle, drinking water installations must be thoroughly flushed immediately upon completion, irrespective of the materials used. Flushing the system ensures that the following requirements are observed:

- Protection of drinking water quality
- Prevention of corrosion damage
- Prevention of functional damage to valves, fittings and equipment
- Cleaning of the inner surface of the pipes

According to EN 806-4 “Specifications for installations inside buildings conveying water for human consumption”, it is necessary to flush the system for drinking water installations as soon as possible upon completion and immediately before putting them into operation. The following regulations must be observed.

- Perform the flushing on warm and cold water systems separately.
- The water must be filtered. The water must not contain any particles > 150 µm, as these can cause damage to the system.
- If the system is not put into operation immediately after the system is flushed, the flushing process must be repeated regularly, with no more than 7 days between repetitions.

Two flushing methods have proven successful in practice:

1. Flushing with water
2. Flushing with a water/air mixture

The following factors must be considered when applying method “1. Flushing with water”:

- Jet regulators, sieves, flow regulators, shower heads or hand-held showers must be dismantled in order to protect them from damage and soiling, and to ensure the maximum possible flow through the pipes.
- All valves and shut-off devices must be fully opened.
- If the system rinse is carried out in sections, it must be started on the lowest floor and continued upwards, moving from floor to floor.
- During the rinsing process the minimum flow rate must be 2 m/s.
- The water content of the system must be completely exchanged at least 20 times.
- When opening the draw-off points, the first draw-off point to be opened must be the one furthest away from the rising pipe.
- Draw-off points are closed in the reverse order: moving from the rising pipe to the end.
- Each draw-off point must be fully opened.

## 8.3 Initial operation

- Do not fill the system with water until standard operation is imminent.
- Delays cause a hygienic risk. Flushing schedules or forced flushing should be carried out to ensure that the water is exchanged regularly.
- The operator should receive the basic planning documents, the records of leak and stress tests, as well as all flushing and training documents at the same time as the operating instructions.
- The operator must be informed that the regular exchange of the water must be ensured.
- The operator must be advised of the dangers presented by a microbiological contamination of the system caused by hot water temperatures that are too low, and cold water temperatures that are too high.
- The operator should be offered a maintenance contract.



# INITIAL OPERATION

## Initial operation protocol: flushing with water

Construction project: .....

Construction stage: .....

Client represented by: .....

Contractor represented by: .....

Pipe system materials: .....

Guide values for the minimum number of draw-off points to be opened, with reference to the largest nominal width of the distribution pipe							
Largest nominal width of the distribution pipe DN in the current flushing section	25	32	40	50	65	80	100
Minimum number of draw-off points to be opened DN 15	2	4	6	8	12	18	28

Preliminary arrangements:

- Water for flushing has been filtered. Filter size < 150 µm
- Jet regulators, sieves, flow regulators, hand-held showers, shower heads have been dismantled
- Maintenance fittings (main shut-off device on each floor and other shut-off devices) have been fully opened
- Sensitive valves, fittings and equipment have been removed and replaced with adaptors

Sequence of the flushing process:

1. The flushing process is carried out in sections, starting at the main shut-off valve and moving towards the furthest draw-off point.
2. On each floor, those draw-off points located furthest away from the rising pipe are fully opened first.
3. All draw-off points are fully opened.
4. After a minimum rinsing period of 5 min (measured from the valve opened last) all draw-off points are closed in reverse order.

Start of the flushing process: .....

End of the flushing process: .....

Final steps:

- Built-in filters and strainers have been cleaned

The flushing of the drinking water system has been properly carried out.

Place ..... Date .....

SYSTEM DESCRIPTION

TRANSPORTATION AND STORAGE

DRINKING WATER HYGIENE

SYSTEM REQUIREMENTS

PLANNING AND DESIGN

WELDING TECHNOLOGY

ASSEMBLY GUIDELINES

INITIAL OPERATION

QUALITY MANAGEMENT

# QUALITY MANAGEMENT

## 9.1 Quality assurance

All incoming goods that are intended for use as raw and auxiliary materials for further processing, are checked for their suitability by POLYMELT Quality Assurance.

The manufacture of quality-controlled pipeline systems requires all necessary procedural steps:

- Monitoring
- Control
- Inspection

Furthermore, all results and procedures are documented.

The minimum requirements for independent company quality control are derived from the corresponding regulations for the quality control of sanitary pipeline systems, in that compliance must also include inspection by a neutral testing institution within the framework of external control.

External control, in addition to external testing of products, includes

- testing of the manufacturer's own required control measures
- examination of the technical equipment requirements
- hygienic and toxicological testing

External control of the POLYMUTAN Installation System in Germany is conducted by the

- Süddeutsches Kunststoffzentrum (Southern German Plastics Centre) (SKZ)
  - Hygiene Institut (Hygiene Institute of) Karlsruhe (TZW),
- which are authorised as testing centres by DVGW (German Association of Gas and Water Facilities), among others.

External control of approvals for foreign usage is conducted in a similar manner.

The suitability of the POLYMELT pipe systems for drinking water has been established by the Technology Water Centre (TWZ) according to the "Guideline for Hygienic Assessment of Organic Materials in Contact with Drinking Water" (KTW Guideline) provided by the German Federal Environmental Agency, and is subject to permanent external control.

### Summary of key points:

- The entire production process is defined, monitored, documented
- Quality management according to DIN EN ISO 9001
- Complies with all applicable standards, laws and regulations
- Monitoring by external institutes
- Certified system

# QUALITY MANAGEMENT

## Quality assurance

The entire production process for POLYMELT pipe systems and fittings is monitored and controlled by POLYMELT quality assurance. All results and procedures are documented. The monitoring is carried out by external institutes and by self-monitoring.

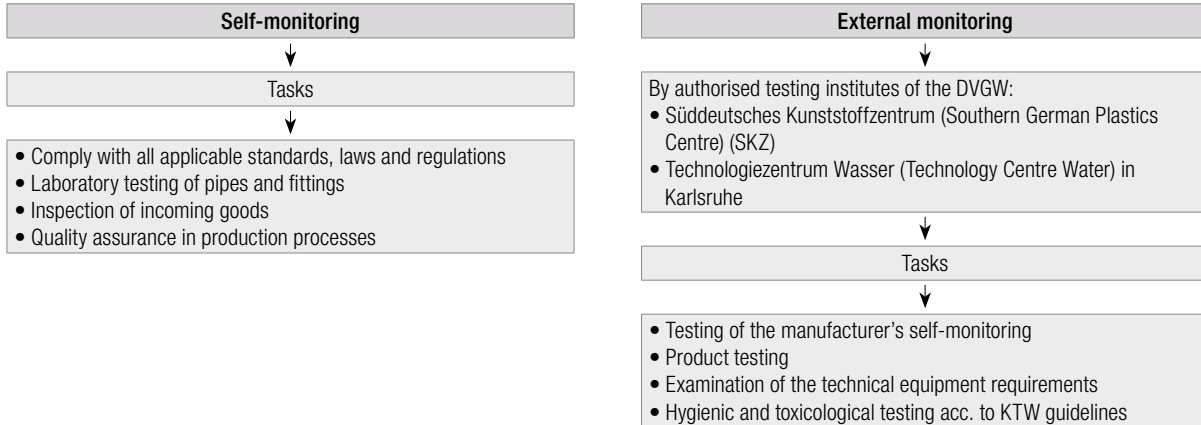

Our organisation is certified in accordance with ISO 9001

Das Kunststoff-Zentrum



## Certificate

The SKZ-Cert GmbH Zertifizierungen certifies to the company



**POLYMELT GmbH**  
**Kirnachstraße 17**  
**87640 Ebenhofen**

the introduction and application of a management system according to  
**ISO 9001:2015**

Scope:  
**Development, production and sales of plastic pipe systems and components.**

The proof has been furnished by an audit.

This certificate is valid from: **05.08.2021** to: **04.08.2024**  
 Certificate No.: **000482.Q/21.N**

Würzburg, 05.08.2021

*Robert Schmitt*  
 Dipl.-Ing. Robert Schmitt  
 Certification Body



SYSTEM DESCRIPTION  
 TRANSPORTATION AND STORAGE  
 DRINKING WATER HYGIENE  
 SYSTEM REQUIREMENTS  
 PLANNING AND DESIGN  
 WELDING TECHNOLOGY  
 ASSEMBLY GUIDELINES  
 INITIAL OPERATION  
 QUALITY MANAGEMENT

# QUALITY MANAGEMENT

## 9.1.1 Approvals

- Tested by the accredited testing institute SKZ
- Hygienically safe in accordance with the KTW guideline of the Federal Environmental Agency
- Compliance with standards according to EN ISO 15874
- Certified by SKZ, DVGW, ÖVGW

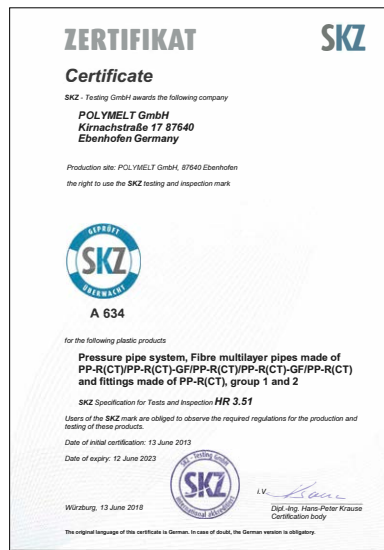

## 9.1.2 Testing institutes for product monitoring and certification



# QUALITY MANAGEMENT

## 9.4 Sustainability

In the development of its products and their production, POLYMELT places emphasis on the sustainable, environmentally friendly and resource-conserving implementation. The raw material polypropylene PP-R can be recycled to 100 %. Any residues from the production can be reused.

Thanks to this advantage it can be processed further for the industry in many different ways. Compared to other materials, the energy expenditure required for the production of POLYMELT products is significantly lower. Furthermore, the process does not produce any environmentally hazardous substances, leading to an excellent environmental performance evaluation overall.

### Advantages PP-R:

- Can be recycled
- Free of halogen
- Free of plasticisers
- Hygienically safe
- Environmentally friendly



SYSTEM  
DESCRIPTION

TRANSPORTATION  
AND STORAGE

DRINKING WATER  
HYGIENE

SYSTEM  
REQUIREMENTS

PLANNING AND  
DESIGN

WELDING  
TECHNOLOGY

ASSEMBLY  
GUIDELINES

INITIAL  
OPERATION

QUALITY  
MANAGEMENT





© Copyright. All contents and graphical representations are protected by copyright and, even in altered form, they may only be reproduced, published or distributed following the express written approval of POLYMELT.

0002\_2021\_12\_POLY21019\_EN

**POLYMELT** GMBH  
Kirnachstraße 17, 87640  
Ebenhofen, Germany  
Tel. +49 8342 70060  
Fax +49 8342 700666  
mail@polymelt.com, www.polymelt.com

